



205 Westwood Ave  
Long Branch, NJ 07740  
1-877-742-TEST (8378)  
Fax: (732) 222-7088  
salesteam@Tequipment.NET

## Measurement Solutions for Refrigeration Technology







# The benefits of electronic refrigeration system analyzers

## The new analyzers from Testo

Testo is again setting standards in refrigeration technology with the new refrigeration system analyzers for measuring, recording, regulating and analyzing refrigeration systems and heat pumps.

What began with accurate and practical pressure and flow velocity measuring instruments and electronic manifolds for the refrigeration trade, now finds its technological continuation in the new refrigeration system analyzers testo 560, 556 and 530.

The high-quality analyzers form a unit composed of highly accurate sensors for measuring pressure, vacuum, temperature (up to 4 temperatures simultaneously), current consumption, oil pressure and refrigerant filling quantities. The instruments have a 4-way valve block with stowable valve knobs (testo 556 and testo 560). The large, backlit display digitally shows the pressure and the condensation and evaporation temperatures. There are 30 refrigerant curves stored in the instrument, which can be updated free of charge via internet and software (testo 556 and testo 560). This makes the instrument family suitable for almost all refrigeration systems, and replaces the complicated mechanical manifolds.

Among the most important characteristics are the recording and documentation of the values measured on site. They can be directly stored in the instrument and later transferred to a PC. Online measurement on site via a PC is also possible.

## Newly developed software "EasyKool"

The newly developed software "EasyKool" offers professional data administration on a PC, and thus optimum refrigerant management. Measurement values can be shown graphically as well as in tabular form. If all actions are recorded during commissioning, a commissioning report can be drawn up. Uninterrupted documentation of data over a defined period of time allows the causes of malfunctions to be objectively diagnosed.

### Learning changes you

Testo's product lines provide flexibility during applications in the pressure and refrigeration sector, helping you to optimize your daily work. Do not hesitate to contact us with your queries. Communication between qualified experts and practitioners is invaluable for the advancement of measurement technology in this sector.

## Linde Kältetechnik GmbH & Co. KG relies on Testo



Mr. Waldvogel, Customer Service Technician, Linde Kältetechnik GmbH & Co. KG

Linde is one of the leading manufacturers of refrigerated and non-refrigerated units for the food sector. Their specialists use modern testo 560 electronic manifolds to record, regulate and measure.

What are the arguments in favour of using Testo's electronic manifolds?

As a manufacturer of top quality measuring instruments for this sector, I am sure you are not hearing for the first time that there were major problems in the past. The multitude of refrigerants required several mechanical measuring instruments with all kinds of gadgets in order to be able to take any kind of usable reading. Our technicians are now delighted with Testo's manifolds. More than 35 refrigerants available and complex conversions have been dispensed with or in other words: This is exactly how we imagined innovations which can be put to practical use – Testo is certainly living up to its reputation as an innovative manufacturer.

What exactly fascinates your specialists?

It's simple really; accurate values and convenient handling such as we have never seen before. Electronic manifolds with high and low pressure, vacuum and temperature socket are tool and measuring instrument in one. Highest efficiency is thus ensured resulting in a significant increase in cost effectiveness during maintenance work.

Once Testo, always Testo?

OK, so we don't want to exaggerate; there are other manufacturers out there who launch excellent products on the market but there is one thing we have certainly established: What Testo has developed with the electronic manifold for refrigeration and pressure technicians is not only unique but has also certainly drawn our attention to the company. We are looking forward to the newest ideas from Testo's innovation factory.





# The right instrument for

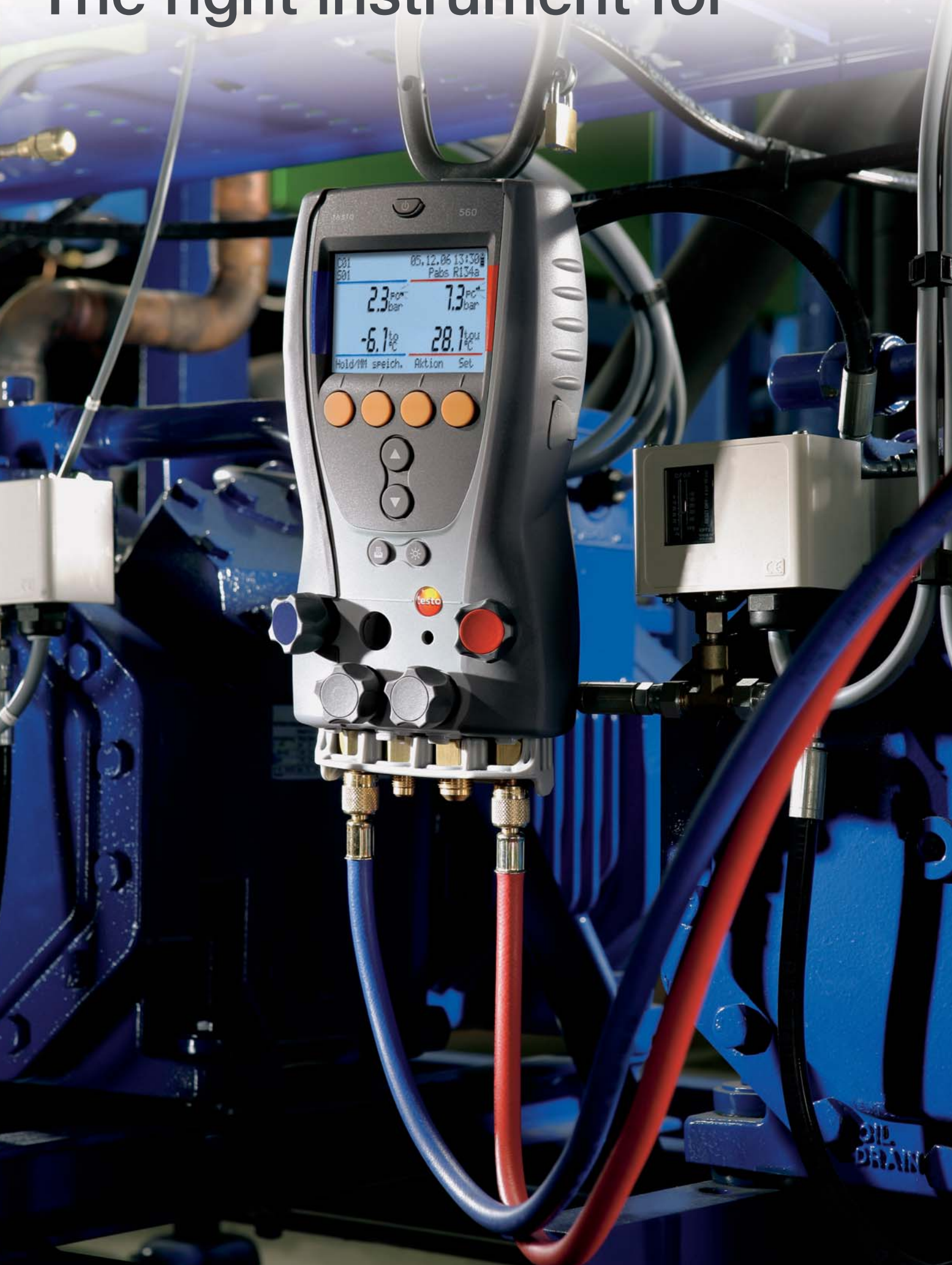





## testo 560 and 556

The new refrigeration system analyzers are the professional solution for service and maintenance. 2 temperature-compensated pressure sensors calculate in real time superheating and subcooling in a refrigeration system or heat pump using a probe which is attached externally. Using a high-quality sensor to measure vacuum, testo 560 is also ideal for system evacuations. This means commissioning can also be carried out.

"EasyKool" PC software offers you convenient data management on your PC: data overviews of all measurements, readings in table and graph form as well as optimum refrigerant management. On account of non-stop data documentation over a defined time period, the causes of downtimes can be diagnosed.

Additional accessories make the refrigeration technician's work easier.

Using the attachable electronic scales it is ensured that the amount of refrigerant filled corresponds to the amount actually required. The attachable switchable current probe (0 to 20 A / 200 A) monitors the compressor's power consumption. The oil pressure probe measures oil pressure in the compressor. The service life of the compressor is extended considerably if the oil level is kept at a sufficiently high level.



Large, backlit display and easy operation using menu buttons



Robust design: Absorbent protective sleeve and concealable valve actuator



Newly designed snap hook with built-in instrument protection (lock optional)



Temperature probe socket and interface for additional sensors



System and error analysis using "EasyKool" PC software



## The professional solution for commissioning, service and maintenance

### testo 560

- On site printout with Testo report printer (optional)
- High-quality sensors measure high/low pressure and temperature
- Calculation of superheating and subcooling in real time
- 4-way valve block with sight glass
- 4 temperature connections (2x cable, 2x wireless)
- Wireless temperature measurement up to 20 m (without obstruction)
- 30 refrigerants are stored in the instrument, more can be downloaded free of charge from the Testo websire with software "EasyKool".
- 60,000 measurement values can be stored
- Further functions:
  - Current measurement
  - Differential pressure measurement
  - Refrigerant stock management when filling or evacuating refrigeration systems
- Vacuum sensor/evacuation
- The sensor measures the absolute pressure and displays the corresponding evaporation temperature of water
- The vacuum sensor is protected from high pressures by a special valve



4-way valve block in testo 556 and 560



Service and maintenance on a refrigeration system using testo 556 and 560, commissioning included

#### testo 560-1

testo 560-1, electronic refrigeration system analyser with vacuum sensor, brass connections, calibration protocol and batteries included

Part no. 0560 5603

#### testo 560-2

testo 560-2, electronic refrigeration system analyser with vacuum sensor, stainless steel connections, calibration protocol and batteries included

Part no. 0560 5604

#### testo 560-1 Set

testo 560-1 refrigeration system analyser, Velcro surface probe, software with USB data cable, mains unit, lock to secure analyser, system case for extensive accessories included

Part no. 0563 5602

#### testo 560-2 Set

testo 560-2 refrigeration system analyser, Velcro surface probe, software with USB data cable, mains unit, lock to secure analyzer, NH3 adapter, system case for extensive accessories included

Part no. 0563 5603

## The Professional Solution for Service and Maintenance

### testo 556

- On-site printout with Testo printer (optional)
- High-quality sensors measure high/low pressure and temperature
- Calculation of superheating and subcooling in real time
- 4-way valve block with sight glass
- 4 temperature probe connections (2x connected by wire, 2x radio)
- Wireless temperature measurement up to 20 m distance (without obstruction)
- 30 refrigerants are stored in the instrument, more refrigerants can be downloaded free of charge from the Testo website using the software "EasyKool"
- 60,000 measurement values can be stored
- Further functions:
  - Current measurement
  - Differential pressure measurement
  - Stock management of refrigerants when filling and evacuating refrigeration systems

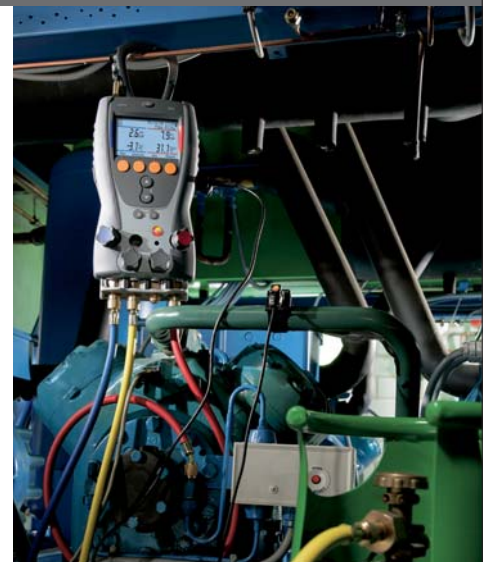

Filling a refrigeration system with testo 556 and 560

#### testo 556-1

testo 556-1, electronic refrigeration system analyser, brass connections, calibration protocol and batteries included

Part no. 0560 5563

#### testo 556-2

testo 556-2, electronic refrigeration system analyser, stainless steel connections, calibration protocol and batteries included

Part no. 0560 5564

#### testo 556-1 Set

testo 556-1 refrigeration system analyser, Velcro surface probe, software with USB data cable, mains unit, lock to secure analyzer, system case for extensive accessories included

Part no. 0563 5561

#### testo 556-2 Set

testo 556-2 refrigeration system analyser, Velcro surface probe, software with USB data cable, mains unit, lock to secure analyser, NH3 adapter, system case for extensive accessories included

Part no. 0563 5562



## The Starter for Service and Maintenance

### testo 523

The starter refrigeration system analyzer for service and maintenance on refrigeration systems and heat pumps. The pressures measured with the two pressure sensors are immediately converted into temperature values according to the selected refrigerant, and displayed in the large, backlit display.

- Calculation of superheating and subcooling in real time
- Display and sightglass illumination
- 2-way valve block
- 1 temperature probe connection
- 30 refrigerants stored in the instrument



Large, backlit display



On-site printout of measurement data on infrared printer

Refilling refrigerant with the testo 523

#### testo 523

testo 523, electronic refrigeration system analyzer, brass connections, calibration protocol and batteries included

Part no. 0560 5231

#### testo 523 Set 1

testo 523 refrigeration system analyser, Velcro surface probe

Part no. 0563 5234

#### testo 523 Set 2

testo 523 refrigeration system analyser, Velcro surface probe, incl. transport case

Part no. 0563 5235

## Technical data testo 523, 556, 560

	testo 523	testo 556	testo 560
<b>Low pressure/High pressure</b>			
Meas. range	25 bar / 50 bar		
Overload	50 bar / 100 bar		
Accuracy ±1 digit	±0.5% fs (Class 0.5)		
Conn.	3 x 7/16" UNF	3 x 7/16" UNF 1 x 5/8" UNF	
Resolution	0,1 bar		
<b>Vacuum</b>			
Meas. range	—		0 to 200 hPa
Overload	—		3 bar*
Resolution			0.1 mbar / 10 Pa
<b>Temperature</b>			
Meas. range	-100 to +200 °C		
Accuracy	Class B ±(0,3 +0,005 tI)		
Resolution	0.1 °C		
Probe connections	1 x plug-in	2 x plug-in (Pt100) 2 x wireless (TC)	
<b>General technical data</b>			
Pressure media	CFC, HFC, N, H <sub>2</sub> O, CO <sub>2</sub> (Stainless steel versions: NH <sub>3</sub> )		
Oper. temp.	-20to +60 °C		
Storage temp.	-20to +60 °C		
Battery type	4 AA batteries		
Battery life	40 h (no light)		
Dimensions	260 x 130 x 70 mm		
Data store in instrument	—		60,000 readings
Protection class	IP54		
Weight	1250 g	1400 g	

\*Sensor protected from high pressures

#### Refrigerants permanently stored in instruments

R-12	R403B	R414b*
R1270	R404A	R417A
R134a	R406a*	R422a*
R22	R407A	R500
R23	R407B	R502
R290	R407C	R507
R401A	R407D	R508**
R401B	R408A	R717**
R401C	R409A	R723**
R402A	R410A	R744
R402B	R413A	R718

\* only testo 523 / 556-1 / 560-1 (brass)

\*\* only testo 556-2 / 560-2 (stainless steel)

In the case of testo 556 and testo 560, additional refrigerants can be downloaded free of charge using the Testo website and "EasyKool software".



## Probes testo 523, 556, 560

Probes testo 523 / testo 556 / testo 560	Illustration	Meas. range	Accuracy	t <sub>99</sub>	Part no.
Pipe wrap probe with Velcro for pipes from Ø 6 mm to Ø 120 mm, Pt 100, 2.9 m cable length	 450 mm 20 mm	-100 to +400 °C	Class A	90 s	0609 5602
Robust, waterproof Pt100 immersion/penetration probe	 114 mm Ø 5 mm Fixed cable 1.2 m 50 mm Ø 3.7 mm	-50 to +400 °C	Class A (-50 to +300 °C), Class B (remaining range)	12 s	0609 1273
Robust, waterproof surface temperature probe, Pt100	 114 mm Ø 5 mm Fixed cable 1.2 m Ø 9 mm	-50 to +400 °C	Class B	40 s	0609 1973
Efficient, robust air probe, Pt100	 114 mm Ø 5 mm Fixed cable 1.2 m 50 mm Ø 4 mm	-50 to +400 °C	Class A (-50 to +300 °C), Class B (remaining range)	70 s	0609 1773
Pipe wrap probe for pipe diameter 5 to 65 mm	 Fixed cable	-50 to +120 °C	Class B	5 s	0609 5605
Probes testo 556 / testo 560	Illustration	Meas. range	Accuracy	Part no.	
Current probe for measuring current consumption of compressors, with switchable measuring range	 Fixed cable	0 to 20/200 A	0 to 9.9 A 4% 10 to 49.9 A 3% 50 to 200 A 2%	0554 5607	
Oil pressure probe for checking oil level in the compressor	 Fixed cable	0 to 25 bar rel	1,5 % of fsv Overload 50 bar	0638 1742	
Scales incl. transport case and batteries (0 to 80 kg), incl. data cable, directly connectable to testo 556/560, overload 120 kg, resolution: 0.01 kg		0 to 80 kg	Resolution 0.01 kg	0554 5606	

## Accessories testo 523, 556, 560

Accessories testo 523 / testo 556 / testo 560	Part no.
Testo fast printer with wireless infrared interface, 1 roll thermal paper and 4 AA batteries	0554 0549
Spare thermal paper for printer (6 rolls)	0554 0568
Lock for wall holder	0554 1747
External fast charger for 1-4 AA rech. batteries, incl. 4 Ni-MH rech. batteries with individual cell charging and charge control display, incl. impulse trickle charging, integrated discharge function, with built-in international mains plug, 100-240 V, 300 mA, 50/60 Hz	0554 0610
Scales incl. transport case and batteries (0 to 80 kg), incl. data cable, directly connectable to testo 556/560, overload 120 kg, resolution: 0.01 kg	0554 5606
Transport case for measuring instrument and accessories	0516 5013
System case for measuring instrument and extensive accessories	0516 5602

Accessories testo 556 / testo 560	Part no.
Plug-in mains adapter, 5 VDC 500 mA with European adapter, 100-250 VAC, 50-60 Hz	0554 0447
USB connection cable, instrument to PC	0449 0047
"EasyKool" software with measurement data management, USB data cable included	0554 5604

Stainless steel adapter for NH <sub>3</sub> (ammonia), 3 connection hoses with 7/16" to 1/2" and 1 connection hose 5/8" to 1/2", hose length 24 cm	0554 5561
----------------------------------------------------------------------------------------------------------------------------------------------------	-----------

Calibration Certificates	Part no.
ISO calibration certificate relative pressure, 3 measurement points distributed over the measurement range	0520 0085
ISO calibration certificate/absolute pressure, 3 meas. points distributed over meas. range	0520 0185
ISO calibration certificate/temperature, meas. instr. with surface probe; calibration points +60°C; +120°C; +180°C	0520 0071
ISO calibration certificate/temperature, for air/immersion probes, calibration points -18°C; 0°C; +60°C	0520 0001
ISO calibration certificate current probe, 3.5-figure	0520 3105
ISO calibration certificate/scales	0520 2620

Note: Calibration certificates apply only to one sensor

### Scales incl. transport case and batteries

- incl. transport case and batteries (0 to 80 kg)
- incl. data cable, directly connectable to testo 556/560
- overload 120 kg
- resolution 0.01 kg



Part no. 0554 5606

## Option: Radio testo 556 / testo 560

### Radio module for upgrading measuring instrument with radio option

Country versions	Radio freq.	Part no.
Radio module for measuring instrument, 869.85 MHz, approval for the countries: DE, FR, UK, BE, NL, ES, IT, SE, AT, DK, FI, HU, CZ, PL, GR, CH, PT, SI, MT, CY, SK, LU, EE, LT, IE, LV, NO	869.85 MHz FSK	0554 0188
Radio module for measuring instrument, 915.00 MHz FSK, approval for USA, CA, CL	915.00 MHz FSK	0554 0190

### Radio probes for immersion/penetration measurements

Radio immersion/penetration probes	Meas. range	Accuracy	Resolution	t <sub>99</sub>
Radio immersion/penetration probe, NTC 	-50 to +275 °C	±0.5 °C (-20 to +80 °C) ±0.8 °C (-50 to -20.1 °C) ±0.8 °C (+80.1 to +200 °C) ±1.5 °C (remaining range)	0.1 °C	t <sub>99</sub> (in water) 12 s

Country versions	Radio freq.	Part no.
Radio immersion/penetration probe, NTC, approval for the countries: DE, FR, UK, BE, NL, ES, IT, SE, AT, DK, FI, HU, CZ, PL, GR, CH, PT, SI, MT, CY, SK, LU, EE, LT, IE, LV, NO	869.85 MHz FSK	0613 1001
Radio immersion/penetration probe, NTC, approval for USA, CA, CL	915.00 MHz FSK	0613 1002

### Assembled for you: Radio handles with probe head

Radio handles with probe head for air-/ immersion-penetration-meas.	Meas. range	Accuracy	Resolution	t <sub>99</sub>
Radio handle for attachable probe heads with T/C probe head for air and immersion/penetration measurement 	-50 to +350 °C Short-term to +500 °C	Radio handle: ±(0.5 °C +0.3% of mv) (-40 to +500 °C) ±(0.7 °C +0.5% of mv) (remaining range) T/C probe head: Class 2	0.1 °C (-50 to +199.9 °C) 1.0 °C (remaining range)	t <sub>99</sub> (in water) 10 s

Country versions	Radio freq.	Part no.
Radio handle for plug-in probe heads, incl. T/C adapter, approval for the countries: DE, FR, UK, BE, NL, ES, IT, SE, AT, DK, FI, HU, CZ, PL, GR, CH, PT, SI, MT, CY, SK, LU, EE, LT, IE, LV, NO	869.85 MHz FSK	0554 0189
T/C probe head for air/immersion/penetration measurement, attachable to radio handle, T/C Type K		0602 0293
Radio handle for plug-in probe heads, incl. T/C adapter, approval for USA, CA, CL	915.00 MHz FSK	0554 0191
T/C probe head for air/immersion/penetration measurement, attachable to radio handle, T/C Type K		0602 0293

Radio handles with probe head for surface measurement	Meas. range	Accuracy	Resolution	t <sub>99</sub>
Radio handle for attachable probe heads with T/C probe head for surface measurement 	-50 to +350 °C Short-term to +500 °C	Radio handle: ±(0.5 °C +0.3% of mv) (-40 to +500 °C) ±(0.7 °C +0.5% of mv) (remaining range) T/C probe head: Class 2	0.1 °C (-50 to +199.9 °C) 1.0 °C (remaining range)	5 s

Country versions	Radio freq.	Part no.
Radio handle for plug-in probe heads, incl. T/C adapter, approval for the countries: DE, FR, UK, BE, NL, ES, IT, SE, AT, DK, FI, HU, CZ, PL, GR, CH, PT, SI, MT, CY, SK, LU, EE, LT, IE, LV, NO	869.85 MHz FSK	0554 0189
T/C probe head for surface measurement, attachable to radio handle, T/C Type K		0602 0394
Radio handle for plug-in probe heads, incl. T/C adapter, approval for USA, CA, CL	915.00 MHz FSK	0554 0191
T/C probe head for surface measurement, attachable to radio handle, T/C Type K		0602 0394





### Radio handles, separate

Radio handles for attachable T/C probes	Meas. range	Accuracy	Resolution
Radio handle for attachable probe heads incl. adapter for attaching T/C probes (Type K) 	-50 to +1000 °C	±(0.7 °C +0.3% of mv) (-40 to +900 °C) ±(0.9 °C +0.5% of mv) (remaining range)	0.1 °C (-50 to +199.9 °C) 1.0 °C (remaining range)

Country versions	Radio freq.	Part no.
Radio handle for plug-in probe heads, incl. T/C adapter, approval for the countries: DE, FR, UK, BE, NL, ES, IT, SE, AT, DK, FI, HU, CZ, PL, GR, CH, PT, SI, MT, CY, SK, LU, EE, LT, IE, LV, NO	869.85 MHz FSK	0554 0189
Radio handle for plug-in probe heads, incl. T/C adapter, approval for USA, CA, CL	915.00 MHz FSK	0554 0191

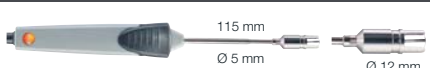
### Radio probes: General technical data

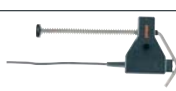
	Radio immersion/penetration probe, NTC	Radio handle	Measuring rate	0.5 s or 10 s, adjustable on handle	Radio transmission	Unidirectional
Battery type	2 x 3V button cell (CR 2032)	2 AAA micro batteries				
Battery life	150 h (meas. rate 0.5 s) 2 months (meas. rate 10 s)	215 h (meas. rate 0.5 s) 6 months (meas. rate 10 s)			Oper. temp.	-20 to +50 °C
			Radio coverage	Up to 20 m (without obstructions)	Storage temp.	-40 to +70 °C
					Protection class	IP54

Probe for probe handle	Illustration	Meas. range	Accuracy	t <sub>99</sub>	Part no.
Fast-action surface probe with sprung thermocouple strip, also for uneven surfaces, measurement range short-term to +500°C, TC Type K 	115 mm Ø 5 mm Ø 12 mm	-60 to +300 °C	Class 2	3 s	0602 0393
Pipe wrap probe with Velcro strip, for temperature measurement on pipes with diameter up to max. 120 mm, T <sub>max</sub> +120°C, TC Type K 	395 mm 20 mm	-50 to +120 °C	Class 1	90 s	0628 0020
Pipe wrap probe for pipe diameter 5 to 65 mm, with exchangeable measuring head. Meas. range short-term to +280°C, TC Type K 		-60 to +130 °C	Class 2	5 s	0602 4592
Spare meas. head for pipe wrap probe, TC Type K		-60 to +130 °C	Class 2	5 s	0602 0092
Clamp probe for measurements on pipes, pipe diameter 15 to 25 mm (max. 1"), meas. range short-term up to +130°C, TC Type K 		-50 to +100 °C	Class 2	5 s	0602 4692



# Leakage Detector for Refrigerants

## testo 316-4

**testo 316-4 Set 1 the fast and reliable leakage detector for all common refrigerants**

**testo 316-4 Set 2 specially for ammonia.**

The sensor is permanently monitored and shows malfunctions or contamination in the display. The use of test leaks is thus no longer necessary. If dirty, the sensor can be easily cleaned and is immediately ready for use again.

When leaks are detected, the display changes from green to red. An audible signal additionally informs of leakages detected. Using the earplug, the testo 316 can also be used in loud surroundings. The maximum indicator function shows maximum leakages and so facilitates the identification of leakage lo-

cations. The flexible gooseneck allows the optimum positioning of the sensor close to the piping or the leakage location.

A simple change of sensor by the user turns the 316-4 into an ammonia detector.

- Very long sensor life
- Optical and audible alarm
- Permanent sensor check
- Easy sensor change by the user
- Earplug socket for secure localization of leakages in loud surroundings

Detectable refrigerants			
Refrigerants Refrigerants group	Reference refrigerant (Lower response threshold specified)	Refrigerant detectable	Refrigerant selection in instrument
CFC		x	R22
H-CFC		x	R22
H-HFC		x	R404a
R12		x	R22
R22	x	x	R22
R123		x	R22
R134a	x	x	R134a
R404	x	x	R404a
R407a, b, c, d, e		x	R134a
R408		x	R22
R409		x	R22
R410a		x	R134a
R505		x	R22
R507		x	R134a
R600/R600a		x	R22
Hydrogen	x	x	H <sub>2</sub>
Ammonia	x	x	NH <sub>3</sub>
R410a		x	R134a
R124		x	R22
R227		x	R134a
R422d		x	R134a
R11		x	R22
R290		x	H <sub>2</sub>
R508		x	R134a
R427a		x	R404a
R1270		x	R22
R1150		x	R22
R170		x	R134a

### testo 316-4 Set 1

Set 1 consisting of testo 316-4, sensor head refr. (CFC, HCFC, HFC, H<sub>2</sub>), case, mains charging unit, earplug)

**Part no. 0563 3164**

### testo 316-4 Set 2

Set 2 consisting of testo 316-4, sensor head NH<sub>3</sub>, case, mains charger unit, earplug

**Part no. 0563 3165**

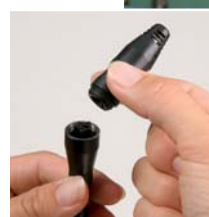

Easy sensor change by the user

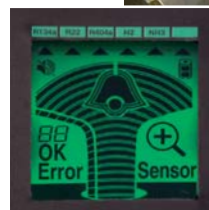

Permanent sensor check



Maximum indicator shows maximum leakages



Fast and reliable detection of leakages, e.g. in refrigeration systems and heat pumps

### Technical data

Meas. parameter	g/a
Detectable	R134a, R22, R404a, H <sub>2</sub> , and all common refrigerants such as CFC, HCFC, HFC NH <sub>3</sub> (separate sensor head)
lower reaction threshold	3 g/a
Reaction time	<1 s
Leakage alarm	optical and audible alarm
Complies with:	1g/year sensitivity acc. to EN 14624 and E 35-422
Length of gooseneck	370 mm
Start-up time	<50 s (0 to +50 °C) <80 s (-20 to 0 °C)
Oper. temp.	-20 to +50 °C
Oper. humidity	20 to 80 %RH
Storage temp.	-25 to +70 °C
Power supply	1 battery block (6 cells NiMh)
Battery life	6 h (Continuous operation)
Dimensions	190 x 57 x 42 mm
Weight	348 g
Warranty	24 months (instrument and sensor)

### Accessories Ordering data

Accessories Ordering data	Part no.
Spare head for refrigerants (CFC, HCFC, HFC, H <sub>2</sub> )	0554 3180
Spare head for ammonia (NH <sub>3</sub> )	0554 3181

## Servicing refrigeration systems



- All measurement parameters for refrigeration systems
- Volume flow and flow velocity (thermal and vane measurement), relative humidity, temperature, draught, lighting intensity



Wireless measurement with radio probes for air/immersion/penetration measurement



PC software for archiving and documenting measurement data (included in delivery) testo 435-2



Measurement data printout on site on Testo printer





## Multi-purpose measuring instruments for analysing refrigeration systems

### testo 435

The testo 435 provides the possibility of analysing indoor air. This serves on the one hand as an indicator of the well-being of people at their workplace, and on the other hand as an important deciding factor in storage and production processes. Indoor air quality furthermore signalizes whether the indoor air system (VAC) is being used with optimum energy economy, or whether it needs to be adjusted with the help of testo 435. In addition to classical probes with a wire, wire-less measurement up to a distance of 20 m (without obstruction) is possible. Damage to the wire or hindrances in usage are thus eliminated. A maximum of three radio probes can be recorded and displayed by testo 435. The radio probes are available for the measurement parameters temperature and, depending on the instrument type, humidity. The optional, easily attachable radio module can be retrofitted at any time.

#### More user comfort

The testo 435 excels through its logical use and easy-to-follow menu. For measurements at different locations, testo 435-2 has the advantage that the readings are allocated to the respective measurement location. For duct and IAQ measurement applications, the instruments can be switched over between user profiles.

#### Absolutely robust instrument concept

The reliability of measuring instruments is a deciding factor. The testo 435 is a robust and reliable measuring instrument with protection class IP 54. The material used works as a built-in pro-

tection against knocks and dirt. The large backlit display is positioned slightly set back in the housing and is thus better protected. The carrying strap on the instrument enables safe transport. Magnets on the back of the instrument ensure secure attachment at the measurement location.

#### Common advantages

- Wide range of probes:
  - Thermal probes with integrated temperature and air humidity measurement
  - Vane and hot wire probes
  - Radio probes for temperature
- Easy use with user profiles
- Printout on Testo printer

#### Further advantages testo 435-2

- Instrument store for 10,000 readings
- PC software for analysing, archiving and documenting measurement data
- Moisture probes with radio or wire
- Possibility of connecting Lux probe
- Possibility of connecting comfort level probe



Fast documentation through measurement data printout on location



Monitoring air turnover in a refrigeration chest

Printer and Accessories	Part no.
Testo fast printer with wireless infrared interface, 1 roll thermal paper and 4 AA batteries	0554 0549
Spare thermal paper for printer (6 rolls), measurement data documentation legible for up to 10 years	0554 0568
Spare thermal paper for printer (6 rolls)	0554 0569
External fast charger for 1-4 AA rech. batteries, incl. 4 Ni-MH rech. batteries with individual cell charging and charge control display, incl. impulse trickle charging, integrated discharge function, with built-in international mains plug, 100-240 V, 300 mA, 50/60 Hz	0554 0610
Further accessories measuring instrument/probes	Part no.
Plug-in mains adapter, 5 VDC 500 mA with European adapter, 100-250 VAC, 50-60 Hz	0554 0447
testovent 410, volume flow funnel, Ø 340 mm/330x330 mm, incl. case	0554 0410
testovent 415, volume flow funnel, Ø 210 mm/210x210 mm, incl. case	0554 0415
Funnel set consisting of funnel for disc outlets (Ø 200) and funnel for ventilator (330 x 330 mm) for in- and outgoing air	0563 4170
Transport and Protection	Part no.
Service case for basic equipment of measuring instrument and probes, dimensions: 400 x 310 x 96 mm	0516 0035
Service case for measuring instrument, probe and accessories, dimensions 520 x 380 x 120 mm	0516 0435
Accessories for testo 435-2 only	Part no.
Handle for plug-in humidity probe head for connection to testo 635 and testo 435, probe cable included, measures/calibrates humidity probe head	0430 9735
testo saline pots for control and humidity adjustment of humidity probes, 11.3 %RH and 75.3 %RH with adapter for humidity probe	0554 0660
Sintered PTFE filter, Ø 12 mm, for corrosive media	0554 0756
Stainless steel sintered cap, Ø 12 mm, is screwed onto humidity probe	0554 0647
Calibration Certificates	Part no.
ISO calibration certificate/temperature, meas. instr. with surface probe; calibration points +60°C; +120°C; +180°C	0520 0071
ISO calibration certificate humidity, Calibration points 11.3 %RH and 75.3 %RH at +25°C	0520 0006
ISO calibration certificate/Velocity, hot wire, vane anemometer, Pitot tube; calibration points 5; 10; 15; 20 m/s	0520 0034

#### testo 435-1

testo 435-1, multi-functional meas. instr., for A/C, ventilation and Indoor Air Quality, with battery and calibration protocol









Part no. 0560 4351

#### testo 435-2

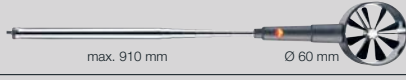

testo 435-2, multi-functional measuring instrument for A/C, ventilation and Indoor Air Quality with readings memory, PC software and USB data transmission cable, incl. battery and calibration protocol

Part no. 0563 4352

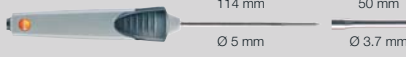
## Suitable probes at a glance

Multi-function probes	Illustration	Meas. range	Accuracy	Part no.	
Thermal velocity probe with built-in temperature and humidity measurement, Ø 12 mm, with telescopic handle (max. 745 mm)	 max. 745 mm      Ø 12 mm	-20 to +70 °C 0 to +100 %RH 0 to +20 m/s	±0.3 °C ±2 %RH (+2 to +98 %RH) ±(0.03 m/s +4% of mv)	0635 1535	
Flow probes	Illustration	Meas. range	Accuracy	Part no.	
Vane meas. probe, 16 mm diameter, with telescopic handle max. 890 mm, e.g. for meas. in ducts	 max. 890 mm      Ø 16 mm	+0.6 to +40 m/s	±(0.2 m/s +1.5% of mv)	0635 9535	
Vane meas. probe, 60 mm diameter, with telescopic handle max. 910 mm, e.g. for meas. at duct exit	 max. 910 mm      Ø 60 mm	+0.25 to +20 m/s	±(0.1 m/s +1.5% of mv)	0635 9335	
Vane meas. probe, 100 mm diameter, for measurements with funnel set 0563 4170		+0.3 to +20 m/s 0 to +50 °C	±(0.1 m/s +1.5% of mv) ±0.5 °C	0635 9435	
Hot wire probe for m/s and °C, Ø probe head 7.5 mm, with telescopic handle (max. 820 mm)	 max. 820 mm      Ø 7.5 mm	0 to +20 m/s -20 to +70 °C	±(0.03 m/s +5% of mv) ±0.3 °C (-20 to +70 °C)	0635 1025	
Air probes	Illustration	Meas. range	Accuracy	t99	Part no.
Efficient, robust NTC air probe	 115 mm      50 mm Ø 5 mm      Ø 4 mm	-50 to +125 °C	±0.2 °C (-25 to +80 °C) ±0.4 °C (remaining range)	60 s	0613 1712
Surface probes	Illustration	Meas. range	Accuracy	t99	Part no.
Fast-action surface probe with sprung thermocouple strip, also for uneven surfaces, measurement range short-term to +500°C, TC Type K	 115 mm      50 mm Ø 5 mm      Ø 12 mm	-60 to +300 °C	Class 2	3 s	0602 0393
Pipe wrap probe for pipe diameter 5 to 65 mm, with exchangeable measuring head. Meas. range short-term to +280°C, TC Type K		-60 to +130 °C	Class 2	5 s	0602 4592
Clamp probe for measurements on pipes, pipe diameter 15 to 25 mm (max. 1"), meas. range short-term up to +130°C, TC Type K		-50 to +100 °C	Class 2	5 s	0602 4692
Immers./penetr. probes	Illustration	Meas. range	Accuracy	t99	Part no.
Waterproof immersion/penetration probe, TC Type K	 114 mm      50 mm Ø 5 mm      Ø 3.7 mm	-60 to +400 °C	Class 2	7 s	0602 1293

### testo 435-2

IAQ probes	Illustration	Meas. range	Accuracy	Part no.
Comfort level probe for degree of turbulence measurement with telescopic handle (max. 820 mm) and stand, meets EN 13779 requirements	 max. 820 mm	0 to +50 °C 0 to +5 m/s	±0.3 °C ±(0.03 m/s +4% of mv)	0628 0109
Lux probe, for measuring light intensity		0 to 100.000 Lux 0 to 300 Hz	Accuracy to DIN 5032, Part 6: f1 = 6% = V(Lambda) adjustment f2 = 5% = cos-like weighting, Class C ±0,1% of mv	0635 0545
Humidity probes	Illustration	Meas. range	Accuracy	Part no.
Humidity/temperature probe	 Ø 12 mm	-20 to +70 °C 0 to +100 %RH	±0.3 °C ±2 %RH (+2 to +98 %RH)	0636 9735



## Technical data / Option: Radio

### Radio module for upgrading measuring instrument with radio option

Country versions	Radio freq.	Part no.
Radio module for measuring instrument, 869.85 MHz, approval for the countries: DE, FR, UK, BE, NL, ES, IT, SE, AT, DK, FI, HU, CZ, PL, GR, CH, PT, SI, MT, CY, SK, LU, EE, LT, IE, LV, NO	869.85 MHz FSK	0554 0188
Radio module for measuring instrument, 915.00 MHz FSK, approval for USA, CA, CL	915.00 MHz FSK	0554 0190

### Assembled for you: Radio handles with probe head

Radio handles with probe head for surface measurement	Meas. range	Accuracy	Resolution	99
<b>Radio handle for attachable probe heads with T/C probe head for surface measurement</b> 	-50 to +350 °C Short-term to +500 °C	Radio handle: ±(0.5 °C +0.3% of mv) (-40 to +500 °C) ±(0.7 °C +0.5% of mv) (remaining range) T/C probe head: Class 2	0.1 °C (-50 to +199.9 °C) 1.0 °C (remaining range)	5 s

Country versions	Radio freq.	Part no.
Radio handle for plug-in probe heads, incl. T/C adapter, approval for the countries: DE, FR, UK, BE, NL, ES, IT, SE, AT, DK, FI, HU, CZ, PL, GR, CH, PT, SI, MT, CY, SK, LU, EE, LT, IE, LV, NO	869.85 MHz FSK	0554 0189
T/C probe head for surface measurement, attachable to radio handle, T/C Type K		0602 0394
Radio handle for plug-in probe heads, incl. T/C adapter, approval for USA, CA, CL	915.00 MHz FSK	0554 0191
T/C probe head for surface measurement, attachable to radio handle, T/C Type K		0602 0394

Radio probes incl. humidity probe head	Meas. range	Accuracy	Resolution
<b>Radio handle for attachable probe heads with humidity probe head</b> 	0 to +100 %RH -20 to +70 °C	±2 %RH (+2 to +98 %RH) ±0.3 °C	0.1 %RH 0.1 °C

Country versions	Radio freq.	Part no.
Radio handle for plug-in probe heads, incl. T/C adapter, approval for the countries: DE, FR, UK, BE, NL, ES, IT, SE, AT, DK, FI, HU, CZ, PL, GR, CH, PT, SI, MT, CY, SK, LU, EE, LT, IE, LV, NO	869.85 MHz FSK	0554 0189
Humidity probe head, attachable to radio handle		0636 9736
Radio handle for plug-in probe heads, incl. T/C adapter, approval for USA, CA, CL	915.00 MHz FSK	0554 0191
Humidity probe head, attachable to radio handle		0636 9736

### Radio probes: General technical data

	Radio immersion/penetration probe, NTC	Radio handle	Measuring rate	Radio transmission	Unidirectional
Battery type	2 x 3V button cell (CR 2032)	2 AAA micro batteries	0.5 s or 10 s, adjustable on handle	Radio transmission	Unidirectional
Battery life	150 h (meas. rate 0.5 s) 2 months (meas. rate 10 s)	215 h (meas. rate 0.5 s) 6 months (meas. rate 10 s)	Radio coverage	Oper. temp.	-20 to +50 °C
			Up to 20 m (without obstructions)	Storage temp.	-40 to +70 °C
				Protection class	IP54

### Technical data

Technical data								testo 435-2
Probe type	NTC	Type K (NiCr-Ni)	Testo humid. sensor, cap.	Vane	Hot wire	CO <sub>2</sub> (IAQ probe)	Absolute pressure probe	Lux
Meas. range	-50 to +150 °C	-200 to +1370 °C	0 to +100 %RH	0 to +60 m/s	0 to +20 m/s	0 to +10000 ppm CO <sub>2</sub>	0 to +2000 hPa	0 to +100000 Lux
Accuracy ±1 digit	±0.2 °C (-25 to +74.9 °C) ±0.4 °C (-50 to -25.1 °C) ±0.4 °C (+75 to +99.9 °C) ±0.5% of mv (remaining range)	±0.3 °C (-60 to +60 °C) ±(0.2 °C +0.3% of mv) (remaining range)	See probe data	See probe data	See probe data	See probe data		See probe data
Resolution	0.1 °C	0.1 °C	0.1 %RH	0.01 m/s (60 vane) 0.1 m/s (16 vane)	0.01 m/s	1 ppm CO <sub>2</sub>	0.1 hPa	1 Lux / 0.1 Hz
Oper. temp.	-20 to +50 °C		Battery life		200 h (typical vane measurement)			
Storage temp.	-30 to +70 °C		Dimensions		220 x 74 x 46 mm			
Battery type	Alkali manganese, mignon, Type AA		Weight		450 g			

## Measures air velocity with telescopic vane

### testo 416

The compact testo 416 anemometer with permanently attached vane probe with telescopic handle (max. 890mm).

Volume flow is shown directly in the display. Accurate volume flow calculation due to easy input of duct area.

Timed and multi-point mean calculation provide information on mean volume flow.

Min/max values can also be shown in the display. The Hold function enables you to freeze the current reading in the display.

- Direct display of volume flow
- Multi-point or timed mean calculation
- Display light
- TopSafe, the indestructible protective case (optional)

#### testo 416

testo 416, vane anemometer with permanently attached 16 mm telescopic vane (max. 890 mm), with battery and calibration protocol

Part no. 0560 4160

#### Technical data

Meas. range	+0.6 to +40 m/s (Application range 0 to +60 °C)		
Accuracy ±1 digit	±(0.2 m/s +1.5% of mv)		
Resolution	0.1 m/s		
Oper. temp.	-20 to +50 °C	Storage temp.	-40 to +85 °C
Battery type	9V block battery, 6F22	Battery life	80 h
Weight	325 g	Dimensions	182 x 64 x 40 mm

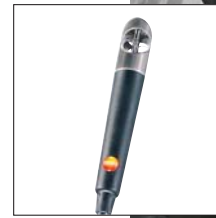

Telescopic vane (length max. 890 mm, Ø 16 mm)



Monitoring air velocity in air conditioning ducts

Accessories Ordering data	Part no.
Case for measuring instrument and probes	0516 0210
TopSafe, protects from impact and dirt	0516 0221
Recharger for 9V rechargeable battery, for external recharging of 0515 0025 battery	0554 0025
9V rech. battery for instrument, instead of battery	0515 0025
ISO calibration certificate velocity, hot wire, vane anemometer, Pitot tube; calibration points 1; 2; 5; 10 m/s	0520 0004
ISO calibration certificate velocity, hot wire, vane anemometer; calibration points 0.5; 0.8; 1; 1.5 m/s	0520 0024
ISO calibration certificate/Velocity, hot wire, vane anemometer, Pitot tube; calibration points 5; 10; 15; 20 m/s	0520 0034

## Measures volume flow and temperature with 100 mm vane

### testo 417

The compact anemometer testo 417 with built-in 100 mm Ø flow / temperature vane for measuring flow velocity, volume flow and temperature. The direction of flow, i.e. blowing or sucking flow, is visible in the display. The optional funnel set enables measurements at ventilation grilles and disc outlets.

- Multi-point and timed mean calculation
- Max/min values

#### testo 417

testo 417, vane anemometer with built-in 100 mm vane, incl. temperature measurement, battery and calibration protocol

Part no. 0560 4170

#### Technical data

Probe type	Vane	NTC	Volume flow
Meas. range	+0.3 to +20 m/s	0 to +50 °C	0 to +99999 m³/h
Accuracy ±1 digit	±(0.1 m/s +1.5% of mv)	±0.5 °C	
Resolution	0.01 m/s	0.1 °C	0.1 m³/h (0 to +99.9 m³/h) 1 m³/h (+100 to +99999 m³/h)
Oper. temp.	0 to +50 °C	Storage temp.	-40 to +85 °C
Battery type	9V block battery, 6F22	Battery life	50 h
Weight	230 g	Dimensions	277 x 105 x 45 mm



Optional funnel set



Measuring exhaust air with testo 417 and built-in 100 mm Ø vane

Accessories Ordering data	Part no.
Case for measuring instrument and probes	0516 0210
Funnel set consisting of funnel for disc outlets (Ø 200) and funnel for ventilator (330 x 330 mm) for in- and outgoing air	0563 4170
Recharger for 9V rechargeable battery, for external recharging of 0515 0025 battery	0554 0025
9V rech. battery for instrument, instead of battery	0515 0025
ISO calibration certificate velocity, hot wire, vane anemometer, Pitot tube; calibration points 1; 2; 5; 10 m/s	0520 0004
ISO calibration certificate velocity, hot wire, vane anemometer; calibration points 0.5; 0.8; 1; 1.5 m/s	0520 0024
ISO calibration certificate/Velocity, hot wire, vane anemometer, Pitot tube; calibration points 5; 10; 15; 20 m/s	0520 0034



## Measuring air velocity with thermal flow probe

### testo 425

The compact anemometer with permanently attached thermal flow probe inc. telescope (max. 820 mm). The volume flow is shown directly in the display. Exact calculation of volume flow due to input of duct area. Additionally, the instrument can be switched over to the current temperature reading.

- Hold button to freeze readings
- Display light
- Auto Off function
- TopSafe, the indestructible protective case (optional)

- Temperature, flow and volume flow measurement
- Multi-point and timed mean calculation
- Max/min values

#### testo 425

testo 425, thermal anemometer with permanently attached flow probe (Ø probe head 7.5 mm), incl. temperature measurement and telescopic handle (max. 820 mm), battery and calibration protocol

Part no. 0560 4251

Accessories Ordering data	Part no.
Case for measuring instrument and probes	0516 0210
TopSafe, protects from impact and dirt	0516 0221
Recharger for 9V rechargeable battery, for external recharging of 0515 0025 battery	0554 0025
9V rech. battery for instrument, instead of battery	0515 0025
ISO calibration certificate velocity, hot wire, vane anemometer, Pitot tube; calibration points 1; 2; 5; 10 m/s	0520 0004
ISO calibration certificate/Velocity, hot wire, vane anemometer, Pitot tube; calibration points 5; 10; 15; 20 m/s	0520 0034



Telescopic flow probe (max. 820 mm)



Monitoring air velocity in air conditioning ducts

#### Technical data

Probe type	Thermal	NTC
Meas. range	0 to +20 m/s	-20 to +70 °C
Accuracy	±(0.03 m/s +5% of mv)	±0.5 °C (0 to +60 °C) ±0.7 °C (remaining range)
Resolution	0.01 m/s	0.1 °C
Oper. temp.	-20 to +50 °C	Storage temp. -40 to +85 °C
Battery type	9V block battery, 6F22	Battery life 20 h
Weight	285 g	Dimensions 182 x 64 x 40 mm

## Measure air flow, volume flow and temperature, with a thermal anemometer

### testo 405

testo 405 is a thermal anemometer. It allows the measurement of air flow velocity, volume flow and temperature. testo 405 is ideal for measuring the flow in ducts or at duct openings or draughty windows.

- Duct holder and holding clip for fast positioning

- m/s and m³/h (volume flow calculation 0 to 99,990 m³/h)
- Measures in ducts and at duct openings

#### testo 405

testo 405; thermal anemometer with duct holder, holding clip, battery included

Part no. 0560 4053

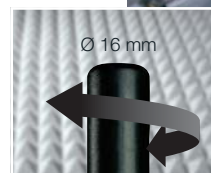

Sensor protected by rotatable protection cap, 300 mm long telescopic handle



Easy-to-read readings thanks to swivel display



Ideal for measurements in ducts

#### Technical data

Meas. range	0 to 5 m/s (-20 to 0 °C) 0 to 10 m/s (0 to +50 °C)	0 to +99990 m³/h
Accuracy	±(0.1 m/s + 5% of mv) (0 to +2 m/s) ±(0.3 m/s + 5% of mv) (remaining range)	±0.5 °C
Resolution	0.01 m/s / 0.1 °C	Battery life Approx. 20 h
Oper. temp.	0 to +50 °C	Battery type 3 batteries Type AAA

Accessories Ordering data	Part no.
testovent 410, volume flow funnel, Ø 340 mm/330x330 mm, incl. case	0554 0410
testovent 415, volume flow funnel, Ø 210 mm/210x210 mm, incl. case	0554 0415
ISO calibration certificate velocity, two point calibration; calibration points 5m/s and 10m/s	0520 0094
ISO calibration certificate velocity, hot wire, vane anemometer, Pitot tube; calibration points 1; 2; 5; 10 m/s	0520 0004

## Thermohygrometer, professional and safe



The right probe for every application: relative humidity, compensation humidity, pressure dewpoint, surface temperature



Probe head on radio handle (optional) for wireless data transmission

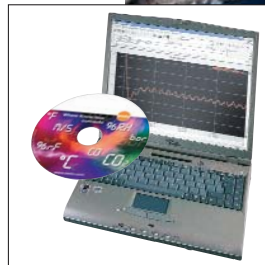

PC software for archiving and documenting measurement data (included in delivery) testo 635-2



Measurement data printout on site on Testo printer





## testo 635

The testo 635 offers the possibility of monitoring and analysing air humidity, material moisture (basis: compensation moisture), and the pressure dewpoint in pressured air systems. The prerequisite for professional moisture measurement is a reliable and precise moisture sensor. The worldwide patented Testo humidity sensor guarantees accurate and long-term stable measurement results.

### Versatility through radio probes

In addition to classical probes with a wire, wireless measurement up to 20 m (without obstruction) is possible. Damage to the wire or hindrance in usage are thus eliminated. A maximum of three radio probes can be recorded and displayed with testo 635. The radio probes are available for the measurement parameters temperature and moisture. The optional, easily attachable radio module is retrofittable at any time.

### Designed for ease of use

The testo 635 excels through its logical use and easy-to-follow menus. For measurements at different locations, testo 635-2 has the advantage that the readings are allocated to the respective measurement location. Selectable user profiles, i.e. programming of the function buttons and menu adapted to the application, allow intuitive operation.

### testo 635-2 with store and software

testo 635-2 has a memory for 10,000 readings. With testo 635-2, characteristic curves for different materials can be stored using the PC software included in delivery, and transmitted to the instrument. Moisture courses can be recorded, analysed and displayed as a graph or table.

### Common advantages

- Connection of three radio probes
- Measurement of air humidity, material compensation moisture and pressure dewpoint
- Display of dewpoint, min., max. and mean values
- Backlit display

### Additional advantages 635-1

- Cyclic printing of the readings on testo printer, e.g. once per minute

### Additional advantages 635-2

- Instrument store for 10,000 readings
- PC software for archiving and documenting measurement data
- Direct display of material moisture thanks to freely storable characteristic curves (Basis: material compensation moisture)
- Storage of single measurements or measurement series by location
- Fast access to the most important functions via user profiles



Cyclic printing of readings on the Testo fast printer, e.g. once per minute (with testo 635-1)



Wireless measurement of warehouse temperature and humidity, with radio handle and attachable humidity probe head

Printer and Accessories	Part no.
Testo fast printer with wireless infrared interface, 1 roll thermal paper and 4 AA batteries	0554 0549
Spare thermal paper for printer (6 rolls), measurement data documentation legible for up to 10 years	0554 0568
Spare thermal paper for printer (6 rolls)	0554 0569
External fast charger for 1-4 AA rech. batteries, incl. 4 Ni-MH rech. batteries with individual cell charging and charge control display, incl. impulse trickle charging, integrated discharge function, with built-in international mains plug, 100-240 V, 300 mA, 50/60 Hz	0554 0610
Further accessories measuring instrument/probes	Part no.
Plug-in mains adapter, 5 VDC 500 mA with European adapter, 100-250 VAC, 50-60 Hz	0554 0447
Handle for plug-in humidity probe head for connection to testo 635 and testo 435, probe cable included, measures/calibrates humidity probe head	0430 9735
testo saline pots for control and humidity adjustment of humidity probes, 11.3 %RH and 75.3 %RH with adapter for humidity probe	0554 0660
Sintered PTFE filter, Ø 12 mm, for corrosive media	0554 0756
Stainless steel sintered cap, Ø 12 mm, is screwed onto humidity probe	0554 0647
Adapter for surface humidity measurement, for humidity probes Ø 12mm	0628 0012
Cap for bore holes, for humidity probe Ø 12 mm, Measures equilibrium moisture in bore holes	0554 2140
Adhesive material for fixing and sealing	0554 0761
Transport and Protection	Part no.
Service case for basic equipment of measuring instrument and probes, dimensions: 400 x 310 x 96 mm	0516 0035
Service case for measuring instrument, probe and accessories, dimensions 520 x 380 x 120 mm	0516 0435
Calibration Certificates	Part no.
ISO calibration certificate humidity, Calibration points 11.3 %RH and 75.3 %RH at +25°C	0520 0006
ISO calibration certificate/humidity, cal. points freely selectable from 5 to 95%RH at +15 to +35°C or at -18 to +80°C	0520 0106
DKD calibration certificate/humidity, electronic hygrometers; calibration points 11.3%RH and 75.3%RH at +25°C	0520 0206

### testo 635-1

testo 635-1, humidity/temperature measuring instrument, with battery and calibration protocol







Part no. 0560 6351

### testo 635-2

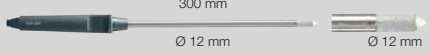
testo 635-2, humidity/temperature measuring instrument with readings memory, PC software and USB data transmission cable, with battery and calibration protocol

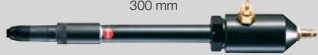
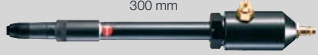
Part no. 0563 6352

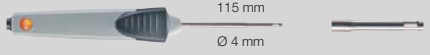
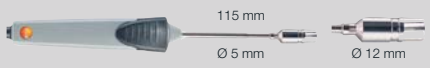
## Suitable probes at a glance / Option: Radio

Humidity probes	Illustration	Meas. range	Accuracy	Part no.	
Humidity/temperature probe		0 to +100 %RH -20 to +70 °C	±2 %RH (+2 to +98 %RH) ±0.3 °C	0636 9735	
Robust humidity probe for meas. up to +125 °C, short-term up to +140 °C, Ø 12 mm, e.g. exhaust ducts, and for meas. of material equilibrium moisture, e.g. bulk goods		0 to +100 %RH -20 to +125 °C	±2 %RH (+2 to +98 %RH) ±0.2 °C	0636 2161	
Thin humidity probe with built-in electronics, incl. 4 attachable PTFE protection caps for material moisture equilibrium measurement		0 to +100 %RH 0 to +40 °C	±2 %RH (+2 to +98 %RH) ±0.2 °C	0636 2135	
Pressure dewpoint probes	Illustration	Meas. range	Accuracy	t <sub>90</sub>	Part no.
Pressure dewpoint probe for measurements in compressed air systems		-30 ... +50 °C tpd 0 to +100 %RH	±0.9 °C tpd (+0.1 to +50 °C tpd) ±1 °C tpd (-4.9 to 0 °C tpd) ±2 °C tpd (-3.9 to -5 °C tpd) ±3 °C tpd (-19.9 to -10 °C tpd) ±4 °C tpd (-30 to -20 °C tpd)	300 s	0636 9835
Precision pressure dewpoint probe for measurements in compressed air systems, including certificate with test point -40 °C tpd		-60 to +50 °C tpd 0 to +100 %RH	±0.8 °C tpd (-4.9 to +50 °C tpd) ±1 °C tpd (-9.9 to -5 °C tpd) ±2 °C tpd (-19.9 to -10 °C tpd) ±3 °C tpd (-29.9 to -20 °C tpd) ±4 °C tpd (-40 to -30 °C tpd)	300 s	0636 9836
Absolute pressure probes	Illustration	Meas. range	Accuracy	Part no.	
Absolute pressure probe 2000 hPa		0 to +2000 hPa	±5 hPa	0638 1835	
Air probes	Illustration	Meas. range	Accuracy	t <sub>99</sub>	Part no.
Robust air probe, T/C Type K		-60 to +400 °C	Class 2	25 s	0602 1793
Surface probes	Illustration	Meas. range	Accuracy	t <sub>99</sub>	Part no.
Fast-action surface probe with sprung thermocouple strip, also for uneven surfaces, measurement range short-term to +500 °C, TC Type K		-60 to +300 °C	Class 2	3 s	0602 0393
Temperature probe to determine U-value, triple sensor system for measuring wall temperature, modelling clay included		-20 to +70 °C	Class 1 U-value: ±0.1 ±2% of fsv*		0614 1635

\*when used with an NTC or wireless humidity probe for measuring outside temperature and 20 K difference between the air inside and outside

### Radio module for upgrading measuring instrument with radio option

Country versions	Radio freq.	Part no.
Radio module for measuring instrument, 869.85 MHz, approval for the countries: DE, FR, UK, BE, NL, ES, IT, SE, AT, DK, FI, HU, CZ, PL, GR, CH, PT, SI, MT, CY, SK, LU, EE, LT, IE, LV, NO	869.85 MHz FSK	0554 0188
Radio module for measuring instrument, 915.00 MHz FSK, approval for USA, CA, CL	915.00 MHz FSK	0554 0190

### Radio probes for immersion/penetration measurements

Radio immersion/penetration probes	Meas. range	Accuracy	Resolution	t <sub>99</sub>
Radio handle for attachable probe heads with T/C probe head for surface measurement		-50 to +275 °C	±0.5 °C (-20 to +80 °C) ±0.8 °C (-50 to -20.1 °C) ±0.8 °C (+80.1 to +200 °C) ±1.5 °C (remaining range)	0.1 °C t <sub>99</sub> (in water) 12 s

Country versions	Radio freq.	Part no.
Radio immersion/penetration probe, NTC, approval for the countries: DE, FR, UK, BE, NL, ES, IT, SE, AT, DK, FI, HU, CZ, PL, GR, CH, PT, SI, MT, CY, SK, LU, EE, LT, IE, LV, NO	869.85 MHz FSK	0613 1001
Radio immersion/penetration probe, NTC, approval for USA, CA, CL	915.00 MHz FSK	0613 1002

### Assembled for you: Radio handles with probe head

Radio handles with probe head for air-/ immersion-penetration-meas.	Meas. range	Accuracy	Resolution	t <sub>99</sub>
Radio handle for attachable probe heads with T/C probe head for air and immersion/penetration measurement		-50 to +350 °C Short-term to +500 °C	Radio handle: ±(0.5 °C +0.3% of mv) (-40 to +500 °C) ±(0.7 °C +0.5% of mv) (remaining range) T/C probe head: Class 2	0.1 °C (-50 to +199.9 °C) 1.0 °C (remaining range) t <sub>99</sub> (in water) 10 s

Country versions	Radio freq.	Part no.
Radio handle for plug-in probe heads, incl. T/C adapter, approval for the countries: DE, FR, UK, BE, NL, ES, IT, SE, AT, DK, FI, HU, CZ, PL, GR, CH, PT, SI, MT, CY, SK, LU, EE, LT, IE, LV, NO	869.85 MHz FSK	0554 0189
T/C probe head for air/immersion/penetration measurement, attachable to radio handle, T/C Type K		0602 0293
Radio handle for plug-in probe heads, incl. T/C adapter, approval for USA, CA, CL	915.00 MHz FSK	0554 0191
T/C probe head for air/immersion/penetration measurement, attachable to radio handle, T/C Type K		0602 0293



## Option: Radio / Technical data

### Assembled for you: Radio handles with probe head

Radio handles with probe head for surface measurement	Meas. range	Accuracy	Resolution	t <sub>99</sub>
<b>Radio handle for attachable probe heads with T/C probe head for surface measurement</b> 	-50 to +350 °C Short-term to +500 °C	Radio handle: ±(0.5 °C + 0.3% of mv) (-40 to +500 °C) ±(0.7 °C + 0.5% of mv) (remaining range) T/C probe head: Class 2	0.1 °C (-50 to +199.9 °C) 1.0 °C (remaining range)	5 s

Country versions	Radio freq.	Part no.
Radio handle for plug-in probe heads, incl. T/C adapter, approval for the countries: DE, FR, UK, BE, NL, ES, IT, SE, AT, DK, FI, HU, CZ, PL, GR, CH, PT, SI, MT, CY, SK, LU, EE, LT, IE, LV, NO	869.85 MHz FSK	0554 0189
T/C probe head for surface measurement, attachable to radio handle, T/C Type K		0602 0394
Radio handle for plug-in probe heads, incl. T/C adapter, approval for USA, CA, CL	915.00 MHz FSK	0554 0191
T/C probe head for surface measurement, attachable to radio handle, T/C Type K		0602 0394

Radio probes incl. humidity probe head	Meas. range	Accuracy	Resolution
<b>Radio handle for attachable probe heads with humidity probe head</b> 	0 to +100 %RH -20 to +70 °C	±2 %RH (+2 to +98 %RH) ±0.3 °C	0.1 %RH 0.1 °C

Country versions	Radio freq.	Part no.
Radio handle for plug-in probe heads, incl. T/C adapter, approval for the countries: DE, FR, UK, BE, NL, ES, IT, SE, AT, DK, FI, HU, CZ, PL, GR, CH, PT, SI, MT, CY, SK, LU, EE, LT, IE, LV, NO	869.85 MHz FSK	0554 0189
Humidity probe head, attachable to radio handle		0636 9736
Radio handle for plug-in probe heads, incl. T/C adapter, approval for USA, CA, CL	915.00 MHz FSK	0554 0191
Humidity probe head, attachable to radio handle		0636 9736

### Radio handles, separate

Radio handles for attachable T/C probes	Meas. range	Accuracy	Resolution
<b>Radio handle for attachable probe heads incl. adapter for attaching T/C probes (Type K)</b> 	-50 to +1000 °C	±(0.7 °C + 0.3% of mv) (-40 to +900 °C) ±(0.9 °C + 0.5% of mv) (remaining range)	0.1 °C (-50 to +199.9 °C) 1.0 °C (remaining range)

Country versions	Radio freq.	Part no.
Radio handle for plug-in probe heads, incl. T/C adapter, approval for the countries: DE, FR, UK, BE, NL, ES, IT, SE, AT, DK, FI, HU, CZ, PL, GR, CH, PT, SI, MT, CY, SK, LU, EE, LT, IE, LV, NO	869.85 MHz FSK	0554 0189
Radio handle for plug-in probe heads, incl. T/C adapter, approval for USA, CA, CL	915.00 MHz FSK	0554 0191

### Radio probes: General technical data

	Radio immersion/penetration probe, NTC	Radio handle	Measuring rate	Radio transmission	Unidirectional
Battery type	2 x 3V button cell (CR 2032)	2 AAA micro batteries	0.5 s or 10 s, adjustable on handle	Radio transmission	Unidirectional
Battery life	150 h (meas. rate 0.5 s) 2 months (meas. rate 10 s)	215 h (meas. rate 0.5 s) 6 months (meas. rate 10 s)	Radio coverage	Oper. temp.	-20 to +50 °C
			Up to 20 m (without obstructions)	Storage temp.	-40 to +70 °C
				Protection class	IP54

### Technical data

Probe type	Type K (NiCr-Ni)	NTC (humidity probe)	Testo humid. sensor, cap.	Absolute pressure probe
Meas. range	-200 to +1370 °C	-40 to +150 °C	0 to +100 %RH	0 to 2000 hPa
Accuracy ±1 digit	±0.3 °C (-60 to +60 °C) ±(0.2 °C + 0.3% of mv) (remaining range)	±0.2 °C (-25 to +74.9 °C) ±0.4 °C (-40 to -25.1 °C) ±0.4 °C (+75 to +99.9 °C) ±0.5% of mv (remaining range)		
Resolution	0.1 °C	0.1 °C	0.1 %RH	0.1 hPa
Oper. temp.	-20 to +50 °C			
Storage temp.	-30 to +70 °C			
Battery type	Alkali manganese, mignon, Type AA			
Battery life	200 h			
Weight	428 g			
Dimensions	220 x 74 x 46 mm			

## Checks ambient conditions – Flexible and robust

### testo 625

The compact instrument with built-in humidity probe head for measuring air moisture and temperature. The large 2 line display shows humidity, wet bulb temperature or dewpoint as well as temperature.

When measuring at hard-to-access points, the humidity probe head can be easily removed and attached to the handle via the probe cable (accessory).

Alternatively, the readings can be transmitted wirelessly over wide distances from the probe to the measuring instrument. To do this, the humidity probe head is attached

to the radio handle (accessory) and the radio module (accessory) is added to testo 625.

- Displays temperature and relative humidity / wet bulb temperature / dewpoint
- Max./min. values
- Hold button to freeze readings
- Display light
- Auto Off function
- Patented humidity sensor
- 2 year guaranteed long-term stability
- TopSafe, instrument protection against dirt and knocks (optional)

#### testo 625

testo 625, humidity/temperature measuring instrument, incl. plug-in humidity probe head, battery and calibration protocol

Part no. 0563 6251



Probe head on handle with probe wire (optional) for measurements at hard-to-access points



Probe head on radio handle (optional) for wireless data transmission over large distances



Monitoring ambient indoor air with attached humidity probe head

Accessories Ordering data	Part no.
Handle for plug-in humidity probe head for connection to testo 625, probe cable included (length 120 cm)	0430 9725
Case for measuring instrument and probes	0516 0210
TopSafe, protects from impact and dirt	0516 0221
9V rech. battery for instrument, instead of battery	0515 0025
Recharger for 9V rechargeable battery, for external recharging of 0515 0025 battery	0554 0025
ISO calibration certificate humidity, Calibration points 11.3 %RH and 75.3 %RH at +25°C	0520 0006
DKD calibration certificate/humidity, electronic hygrometers; calibration points 11.3%RH and 75.3%RH at +25°C	0520 0206

Technical data			
Probe type	NTC	Testo humid. sensor, cap.	Type K (NiCr-Ni)
Meas. range	-10 to +60 °C	0 to +100 %RH	-200 to +1370 °C
Accuracy ±1 digit	±0.5 °C	±2.5 %RH (+5 to +95 %RH)	
Resolution	0.1 °C	0.1 %RH	0.1 °C
Oper. temp.	-20 to +50 °C		
Storage temp.	-40 to +85 °C		
Battery type	9V block battery, 6F22		
Battery life	70 h (without radio operation)		
Dimensions	182 x 64 x 40 mm		

### Radio module for upgrading measuring instrument with radio option

Country versions	Radio freq.	Part no.
Radio module for measuring instrument, 869.85 MHz, approval for the countries: DE, FR, UK, BE, NL, ES, IT, SE, AT, DK, FI, HU, CZ, PL, GR, CH, PT, SI, MT, CY, SK, LU, EE, LT, IE, LV, NO	869.85 MHz FSK	0554 0188
Radio module for measuring instrument, 915.00 MHz FSK, approval for USA, CA, CL	915.00 MHz FSK	0554 0190

### Radio handles, separate

#### Radio handles for humidity probe head

Radio handle for attachable humidity probe head (humidity probe head included in delivery of testo 625)



Country versions	Radio freq.	Part no.
Radio handle for plug-in probe heads, incl. T/C adapter, approval for the countries: DE, FR, UK, BE, NL, ES, IT, SE, AT, DK, FI, HU, CZ, PL, GR, CH, PT, SI, MT, CY, SK, LU, EE, LT, IE, LV, NO	869.85 MHz FSK	0554 0189
Radio handle for plug-in probe heads, incl. T/C adapter, approval for USA, CA, CL	915.00 MHz FSK	0554 0191

#### Radio probes: General technical data

	Radio immersion/penetration probe, NTC	Radio handle	Measuring rate	Radio transmission	Unidirectional
Battery type	2 x 3V button cell (CR 2032)	2 AAA micro batteries	0.5 s or 10 s, adjustable on handle	Oper. temp.	-20 to +50 °C
Battery life	150 h (meas. rate 0.5 s) 2 months (meas. rate 10 s)	215 h (meas. rate 0.5 s) 6 months (meas. rate 10 s)	Radio coverage	Storage temp.	-40 to +70 °C
			Up to 20 m (without obstructions)	Protection class	IP54

## Monitor production conditions – efficiently and accurately

### testo 608-H1 / testo 608-H2

The affordable standard testo 608-H1 hygrometer measures humidity, temperature and dewpoint.

The efficient testo 608-H2 alarm hygrometer with LED alarm function for accurate signals when limits are exceeded.

- With dewpoint calculation and Max/Min value display
- Humidity sensor not affected by condensation



Display can be read from a great distance



testo 608-H2 with LED alarm

Monitoring ambient indoor air



#### testo 608-H1

Humidity/dewpoint/temperature measuring instrument incl. battery

Part no. 0560 6081

#### testo 608-H2

Humidity/dewpoint/temperature measuring instrument, incl. LED alarm, battery and calibration protocol

Part no. 0560 6082

Technical data	testo 608-H1	testo 608-H2
Meas. range	+10 to +95 %RH 0 to +50 °C -20 to +50 °C td	+2 to +98 %RH -10 to +70 °C -40 to +70 °C td
Accuracy ±1 digit	±3 %RH (+10 to +95 %RH) ±0.5 °C (at +25 °C)	±2 %RH (+2 to +98 %RH) ±0.5 °C (at +25 °C)
Resolution	0.1 %RH / 0.1 °C	0.1 %RH / 0.1 °C
Oper. temp.	0 to +50 °C	-10 to +70 °C
Storage temp.	-40 to +70 °C	Measuring rate 18 s
Battery life	8736 h	Weight 168 g
Dimensions	120 x 89 x 40 mm	

Accessories Ordering data	Part no.
ISO calibration certificate humidity, Calibration points 11.3 %RH and 75.3 %RH at +25°C	0520 0006

## Versatile and Easy Measurement of Air Humidity

### testo 605-H1

The thermohygrometer you can bend; small, compact and accurate. The long-term stable sensor guarantees correct results even after years of use.

- With dewpoint calculation °C td
- Humidity sensor unaffected by condensation
- Use clip for attachment to breast pocket

#### testo 605-H1

testo 605-H1: thermohygrometer with duct holder, incl. attachment clip and battery

Part no. 0560 6053

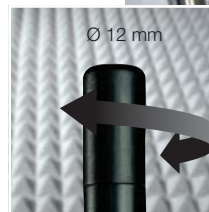

Sensor protection due to rotatable protective cap, probe shaft 125 mm long



With flexible joint

Monitoring air humidity in an air conditioning duct



Accessories Ordering data	Part no.
ISO calibration certificate/humidity, Calibration point 75.3%RH at +25°C	0520 0096
ISO calibration certificate humidity, Calibration points 11.3 %RH and 75.3 %RH at +25°C	0520 0006

Technical data			
Meas. range	+5 to +95 %RH 0 to +50 °C	-20 to +50 °C td	
Accuracy ±1 digit	±3 %RH / ±0.5 °C		
Resolution	0.1 %RH / 0.1 °C	Battery life	Approx. 1000 h
Oper. temp.	0 to +50 °C	Battery type	3 batteries Type AAA



## Highly precise alarm and logger thermometer - with measurement location management

### testo 735

#### Measuring several temperatures simultaneously

testo 735 – the highly versatile multi-channel measuring instrument. Fully equipped, up to 6 temperature probes can be recorded and displayed: Three radio probes and three attachable probes. For classical probes with wire, two inputs for fast thermoelement probes (Type K/T/J/S) and one input for highly precise Pt100 probes are available. The highly precise immersion/penetration probe reaches an accuracy of up to 0.05 °C via the Pt100 probe input. The resolution of the probe is 0.001 °C.



Wireless measurement with radio probes for air, immersion and penetration measurement

#### Versatility through radio probes

Readings can be transmitted to the testo 735 over a distance of up to 20 m (without obstruction) by radio. This takes place using the optional radio module and the corresponding probes. Damage to the wire or hindrances in usage are thus eliminated.



### Common advantages

- Connection of 3 attachable probes and three radio probes
- Data printout on the testo printer
- Audible alarm when limit values are exceeded
- System accuracy up to 0.05 °C
- Display of Delta T, min., max. and mean values
- Backlit display
- Protection class IP 65

- Instrument store for 10,000 readings
- PC software for archiving and documenting measurement data
- Measurement values can be shown in the display and simultaneously transferred to a PC and stored
- Storage of single measurements or measurement series by measurement location
- Quick access to the most important functions via user profiles
- Adjustment software for convenient calibration data management

### Further advantages testo 735-1

- Cyclical printing of readings on testo printer, e.g. once a minute

### Further advantages testo 735-2



PC software for archiving and documenting readings (included in delivery) testo 735-2

Monitoring temperature in a walk-in freezer

#### testo 735-1

testo 735-1, 3 channel temperature measuring instrument T/C Type K/T/J/S/Pt100, audible alarm, connection for max. 3 optional radio probes, incl. battery and calibration protocol

Part no. 0560 7351

#### testo 735-2

testo 735-2, 3 channel temp. meas. instr. T/C Type K/T/J/S/Pt100, audible alarm, connection for max. 3 optional radio probes, with readings memory, PC software and USB data transmission cable, with battery and calibration protocol

Part no. 0563 7352







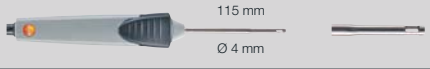
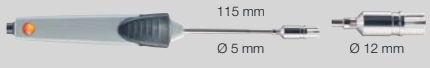
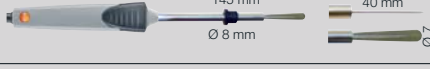
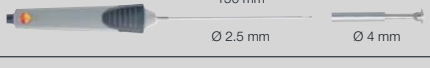

Additional accessories	Part no.
Software for adjustment testo 735-2 with user management, incl. USB data transfer cable	0554 0823
Plug-in mains adapter, 5 VDC 500 mA with European adapter, 100-250 VAC, 50-60 Hz	0554 0447
Extension cable, 5m, for thermocouple probe Type K	0554 0592
Silicone heat paste (14g), Tmax = +260°C, improves heat transfer in surface probes	0554 0004
Handle for attachable measurement tips	0409 1092
Transport and Protection	Part no.
Service case for basic equipment of measuring instrument and probes, dimensions: 400 x 310 x 96 mm	0516 0035
Service case for measuring instrument, probe and accessories, dimensions 520 x 380 x 120 mm	0516 0735
Calibration Certificates	Part no.
ISO calibration certificate/temperature, single point calibration for surface thermometer; calibration point +60°C	0520 0072
ISO calibration certificate/temperature, single point calibration for surface thermometer; calibration point +120°C	0520 0073
ISO calibration certificate/temperature, for air/immersion probes, calibration points -18°C; 0°C; +60°C	0520 0001
ISO calibration certificate/temperature, for air/immersion probes, calibration points -8°C; 0°C; +40°C	0520 0181
ISO calibration certificate/temperature, Meas. instr. with air/immersion probe; cal. points 0°C; +150°C; +300°C (Applies only to immersion/penetration probe 0602 2693)	0520 0021

Printer and Accessories	Part no.
Testo fast printer with wireless infrared interface, 1 roll thermal paper and 4 AA batteries	0554 0549
Spare thermal paper for printer (6 rolls), measurement data documentation legible for up to 10 years	0554 0568
Spare thermal paper for printer (6 rolls)	0554 0569
External fast charger for 1-4 AA rech. batteries, incl. 4 Ni-MH rech. batteries with individual cell charging and charge control display, incl. impulse trickle charging, integrated discharge function, with built-in international mains plug, 100-240 V, 300 mA, 50/60 Hz	0554 0610

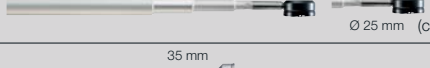
#### Technical data

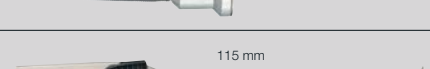
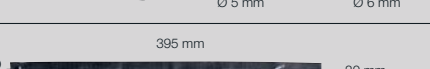
Probe type	Pt100	Pt100 with probe 0614 0235	Type K (NiCr-Ni)	Type T (Cu-CuNi)	Type J (Fe-CuNi)	Type S (Pt10Rh-Pt)	
Meas. range	-200 to +800 °C	-40 to +300 °C	-200 to +1370 °C	-200 to +400 °C	-200 to +1000 °C	0 to +1760 °C	
Accuracy ±1 digit	±0.2 °C (-100 to +199.9 °C) ±0.2% of mv (remaining range)	See probe data	±0.3 °C (-60 to +60 °C) ±(0.2 °C + 0.3% of mv) (remaining range)	±0.3 °C (-60 to +60 °C) ±(0.2 °C + 0.3% of mv) (remaining range)	±0.3 °C (-60 to +60 °C) ±(0.2 °C + 0.3% of mv) (remaining range)	±1 °C (0 to +1760 °C)	
Resolution	0.05 °C	0.001 °C (-40 to +199.999 °C) 0.01 °C (remaining range)	0.1 °C	0.1 °C	0.1 °C	1 °C	
Oper. temp.	-20 to +50 °C	Battery type	Alkali manganese, mignon, Type AA	Battery life	Approx. 300 h with TC probe Approx. 250 h with Pt100 Approx. 60 h with 0614 0235	Dimensions	220 x 74 x 46 mm
Storage temp.	-30 to +70 °C					Protection class	IP65
						Weight	428 g

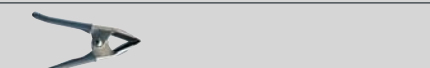
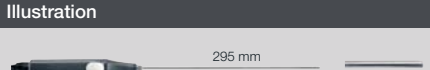
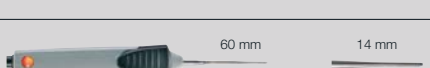
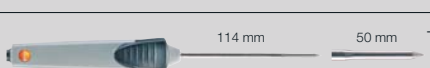
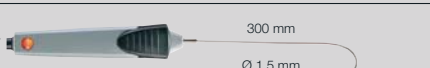
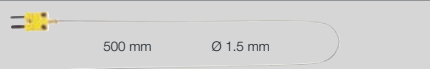
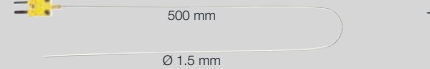
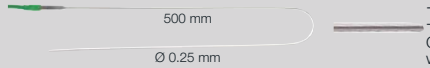
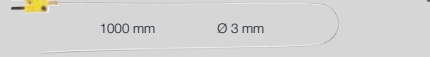
## Suitable probes at a glance

Air probes	Illustration	Meas. range	Accuracy	t <sub>99</sub>	Part no.
Robust air probe, T/C Type K	 115 mm Ø 4 mm	-60 to +400 °C	Class 2	25 s	0602 1793
Surface probes	Illustration	Meas. range	Accuracy	t <sub>99</sub>	Part no.
Fast-action surface probe with sprung thermocouple strip, also for uneven surfaces, measurement range short-term to +500°C, TC Type K	 115 mm Ø 5 mm    Ø 12 mm	-60 to +300 °C	Class 2	3 s	0602 0393
Fast-reaction paddle surface probe, for measurements in inaccessible places, e.g. narrow apertures and slots, TC Type K	 145 mm Ø 8 mm    40 mm	0 to +300 °C	Class 2	5 s	0602 0193
Efficient, waterproof surface probe with small measurement head for flat surfaces, TC Type K	 150 mm Ø 2.5 mm    Ø 4 mm	-60 to +1000 °C	Class 1	20 s	0602 0693
Fast-action surface probe with sprung thermocouple strip, bent, also for uneven surfaces, measurement range short-term to +500°C, TC Type K	 80 mm    50 mm Ø 5 mm    Ø 12 mm	-60 to +300 °C	Class 2	3 s	0602 0993
Flat head surface probe with telescopic handle max. 680 mm for measurements at hard-to-access points, TC Type K	 680 mm    12 mm Ø 25 mm	-50 to +250 °C	Class 2	3 s	0602 2394
Magnetic probe, adhesive force approx. 20 N, with magnets, for measurements on metal surfaces, TC Type K	 35 mm Ø 20 mm	-50 to +170 °C	Class 2		0602 4792
Magnetic probe, adhesive force approx. 10 N, with magnets, for higher temp., for measurements on metal surfaces, TC Type K	 75 mm Ø 21 mm	-50 to +400 °C	Class 2		0602 4892
Waterproof surface probe with widened measurement tip for flat surfaces, T/C Type K	 115 mm Ø 5 mm    Ø 6 mm	-60 to +400 °C	Class 2	30 s	0602 1993
Pipe wrap probe with Velcro strip, for temperature measurement on pipes with diameter up to max. 120 mm, T <sub>max</sub> +120°C, TC Type K	 395 mm    20 mm	-50 to +120 °C	Class 1	90 s	0628 0020
Pipe wrap probe for pipe diameter 5 to 65 mm, with exchangeable measuring head. Meas. range short-term to +280°C, TC Type K		-60 to +130 °C	Class 2	5 s	0602 4592
Spare meas. head for pipe wrap probe, TC Type K	 35 mm 15 mm	-60 to +130 °C	Class 2	5 s	0602 0092
Clamp probe for measurements on pipes, pipe diameter 15 to 25 mm (max. 1"), meas. range short-term up to +130°C, TC Type K		-50 to +100 °C	Class 2	5 s	0602 4692
Immersion/penetr. probes	Illustration	Meas. range	Accuracy	t <sub>99</sub>	Part no.
Highly accurate Pt100 immersion/penetration probe incl. factory certificate (test points 0 °C and +156 °C)	 295 mm Ø 4 mm	-40 to +300 °C	±0.05 °C (+0.01 to +100 °C) ±(0.05 °C + 0.05% of mv) (remaining range)	60 s	0614 0235
Fast-action, waterproof immersion/penetration probe, TC Type K (Calibration not possible over +300 °C)	 60 mm Ø 5 mm    14 mm Ø 1.5 mm	-60 to +800 °C	Class 1	3 s	0602 2693
Waterproof immersion/penetration probe, TC Type K	 114 mm Ø 5 mm    50 mm Ø 3.7 mm	-60 to +400 °C	Class 2	7 s	0602 1293
Efficient and fast-action immersion probe, waterproof, TC Type K	 300 mm Ø 1.5 mm	-60 to +1000 °C	Class 1	2 s	0602 0593
Immersion tip, flexible, TC Type K	 500 mm    Ø 1.5 mm	-200 to +1000 °C	Class 1	5 s	0602 5792
Immersion tip, flexible, TC Type K	 500 mm Ø 1.5 mm	-200 to +40 °C	Class 3	5 s	0602 5793
Flexible, low-mass immersion measurement tip, ideal for measurements in small volumes such as petri dishes, or for surface measurements (e.g. attached with adhesive tape), TC Type K	 500 mm Ø 0.25 mm	-200 to +1000 °C	Class 1	1 s	0602 0493
Immersion measurement tip, flexible, for measurements in air/exhaust gases (not suitable for measurements in smelters), TC Type K	 1000 mm    Ø 3 mm	-200 to +1300 °C	Class 1	4 s	0602 5693



## Suitable probes at a glance / Option: Radio

Thermocouples	Illustration	Meas. range	Accuracy	t <sub>99</sub>	Part no.
Thermocouple with TC adapter, flexible, 800mm long, fibre glass, TC Type K		-50 to +400 °C	Class 2	5 s	0602 0644
Thermocouple with TC adapter, flexible, 1500mm long, fibre glass, TC Type K		-50 to +400 °C	Class 2	5 s	0602 0645
Thermocouple with TC adapter, flexible, 1500mm long, PTFE, TC Type K		-50 to +250 °C	Class 2	5 s	0602 0646

### Radio module for upgrading measuring instrument with radio option

Country versions	Radio freq.	Part no.
Radio module for measuring instrument, 869.85 MHz, approval for the countries: DE, FR, UK, BE, NL, ES, IT, SE, AT, DK, FI, HU, CZ, PL, GR, CH, PT, SI, MT, CY, SK, LU, EE, LT, IE, LV, NO	869.85 MHz FSK	0554 0188
Radio module for measuring instrument, 915.00 MHz FSK, approval for USA, CA, CL	915.00 MHz FSK	0554 0190

### Assembled for you: Radio handles with probe head

Radio handles with probe head for air-/ immersion-penetration-meas.	Meas. range	Accuracy	Resolution	t <sub>99</sub>	
<b>Radio handle for attachable probe heads with T/C probe head for air and immersion/penetration measurement</b>		-50 to +350 °C Short-term to +500 °C	Radio handle: ±(0.5 °C +0.3% of mv) (-40 to +500 °C) ±(0.7 °C +0.5% of mv) (remaining range) T/C probe head: Class 2	0.1 °C (-50 to +199.9 °C) 1.0 °C (remaining range)	t <sub>99</sub> (in water) 10 s

Country versions	Radio freq.	Part no.
Radio handle for plug-in probe heads, incl. T/C adapter, approval for the countries: DE, FR, UK, BE, NL, ES, IT, SE, AT, DK, FI, HU, CZ, PL, GR, CH, PT, SI, MT, CY, SK, LU, EE, LT, IE, LV, NO	869.85 MHz FSK	0554 0189
T/C probe head for air/immersion/penetration measurement, attachable to radio handle, T/C Type K		0602 0293
Radio handle for plug-in probe heads, incl. T/C adapter, approval for USA, CA, CL	915.00 MHz FSK	0554 0191
T/C probe head for air/immersion/penetration measurement, attachable to radio handle, T/C Type K		0602 0293

Radio handles with probe head for surface measurement	Meas. range	Accuracy	Resolution	t <sub>99</sub>	
<b>Radio handle for attachable probe heads incl. T/C probe head for surface measurement</b>		-50 to +350 °C Short-term to +500 °C	Radio handle: ±(0.5 °C +0.3% of mv) (-40 to +500 °C) ±(0.7 °C +0.5% of mv) (remaining range) T/C probe head: Class 2	0.1 °C (-50 to +199.9 °C) 1.0 °C (remaining range)	5 s

Country versions	Radio freq.	Part no.
Radio handle for plug-in probe heads, incl. T/C adapter, approval for the countries: DE, FR, UK, BE, NL, ES, IT, SE, AT, DK, FI, HU, CZ, PL, GR, CH, PT, SI, MT, CY, SK, LU, EE, LT, IE, LV, NO	869.85 MHz FSK	0554 0189
T/C probe head for surface measurement, attachable to radio handle, T/C Type K		0602 0394
Radio handle for plug-in probe heads, incl. T/C adapter, approval for USA, CA, CL	915.00 MHz FSK	0554 0191
T/C probe head for surface measurement, attachable to radio handle, T/C Type K		0602 0394

### Radio handles, separate

Radio handles for attachable T/C probes	Meas. range	Accuracy	Resolution
<b>Radio handle for attachable probe heads incl. adapter for attaching T/C probes (Type K)</b>		-50 to +1000 °C	±(0.7 °C +0.3% of mv) (-40 to +900 °C) ±(0.9 °C +0.5% of mv) (remaining range)

Country versions	Radio freq.	Part no.
Radio handle for plug-in probe heads, incl. T/C adapter, approval for the countries: DE, FR, UK, BE, NL, ES, IT, SE, AT, DK, FI, HU, CZ, PL, GR, CH, PT, SI, MT, CY, SK, LU, EE, LT, IE, LV, NO	869.85 MHz FSK	0554 0189
Radio handle for plug-in probe heads, incl. T/C adapter, approval for USA, CA, CL	915.00 MHz FSK	0554 0191

### Radio probes: General technical data

	Radio immersion/penetration probe,	Radio handle	Measuring rate	Radio transmission	Unidirectional
Battery type	2 x 3V button cell (CR 2032)	2 AAA micro batteries	0.5 s or 10 s, adjustable on handle		
Battery life	150 h (meas. rate 0.5 s) 2 months (meas. rate 10 s)	215 h (meas. rate 0.5 s) 6 months (meas. rate 10 s)	Radio coverage	Oper. temp.	-20 to +50 °C
			Up to 20 m (without obstructions)	Storage temp.	-40 to +70 °C
				Protection class	IP54

## Fast Temperature Measurement with Wide Measurement Range

### testo 925

#### Single channel thermometer

The one channel temperature measuring instrument for connection to reliable, fast-action thermocouple probes. An additional temperature probe can be displayed in testo 925; data is transmitted by radio, i.e. wirelessly. An audible alarm sounds if limit values are exceeded. Current measurement data as well as max/min data can be printed on site on the Testo fast printer.

#### Advantages testo 925

- 1 channel measuring instrument with optional radio probe
- An audible alarm sounds when limit values are exceeded

#### Common advantages testo 925, testo 922

- On site printout on Testo fast printer
- Continuous display of max/min values
- Hold button to freeze reading
- TopSafe, indestructible case, protects from dirt and impact (option)
- Display light

#### testo 925

testo 925, 1 channel temperature measuring instrument T/C Type K, audible alarm, connection of an optional radio probe, with battery and calibration protocol

**Part no. 0560 9250**

### testo 922

#### Differential thermometer

The differential thermometer records temperature values from 2 connected thermocouple probes and displays them simultaneously. The reading from an additional temperature probe can also be wirelessly displayed in the testo 922 measuring instrument; i.e. measurement data is transmitted by radio.

Differential temperature can be called up immediately. Current measurement data such as max/min data can be printed on the Testo fast printer on site. It is possible to print measurement data once a minute, for example, on the printer if cyclical printing is in operation.

#### Advantages testo 922

- 2 channel measuring instrument with optional radio probe
- Displays differential temperature
- Cyclical printing of readings, e.g. once a minute

#### testo 922

testo 922, 2 channel temperature measuring instrument T/C Type K, connection of an optional radio probe, with battery and calibration protocol

**Part no. 0560 9221**



Wireless measurement with radio probes



Monitoring temperature at exhaust outlets



Simultaneous recording of temperature by two connected probes and display of differential temperature



Monitoring differential temperature in compressors with pipe wrap probes

Printer and Accessories	Part no.
Testo fast printer with wireless infrared interface, 1 roll thermal paper and 4 AA batteries	0554 0549
Spare thermal paper for printer (6 rolls), measurement data documentation legible for up to 10 years	0554 0568
Spare thermal paper for printer (6 rolls)	0554 0569
External fast charger for 1-4 AA rech. batteries, incl. 4 Ni-MH rech. batteries with individual cell charging and charge control display, incl. impulse trickle charging, integrated discharge function, with built-in international mains plug, 100-240 V, 300 mA, 50/60 Hz	0554 0610
Additional accessories	Part no.
9V rech. battery for instrument, instead of battery	0515 0025
Recharger for 9V rechargeable battery, for external recharging of 0515 0025 battery	0554 0025
Handle for attachable measurement tips	0409 1092
Extension cable, 5m, for thermocouple probe Type K	0554 0592
Silicone heat paste (14g), Tmax = +260°C, improves heat transfer in surface probes	0554 0004
Transport and Protection	Part no.
TopSafe, protects from impact and dirt (testo 925)	0516 0221
TopSafe, protects from impact and dirt (testo 922)	0516 0222
Case for measuring instrument and probes	0516 0210
Transport case for meas. instr. and probes (405 x 170 x 85 mm)	0516 0201
Transport case for measuring instrument, 3 probes and accessories (430 x 310 x 85 mm)	0516 0200
Calibration Certificates	Part no.
ISO calibration certificate/temperature, for air/immersion probes, calibration points -18°C; 0°C; +60°C	0520 0001
DKD calibration certificate/temperature, meas. instr. with air/immersion probe; calibration points -20°C; 0°C; +60°C	0520 0211

## Suitable probes at a glance

Air probes	Illustration	Meas. range	Accuracy	t99	Part no.
Robust air probe, T/C Type K		-60 to +400 °C	Class 2	25 s	0602 1793
Surface probes	Illustration	Meas. range	Accuracy	t99	Part no.
Fast-action surface probe with sprung thermocouple strip, also for uneven surfaces, measurement range short-term to +500°C, TC Type K		-60 to +300 °C	Class 2	3 s	0602 0393
Fast-reaction paddle surface probe, for measurements in inaccessible places, e.g. narrow apertures and slots, TC Type K		0 to +300 °C	Class 2	5 s	0602 0193
Efficient, waterproof surface probe with small measurement head for flat surfaces, TC Type K		-60 to +1000 °C	Class 1	20 s	0602 0693
Fast-action surface probe with sprung thermocouple strip, bent, also for uneven surfaces, measurement range short-term to +500°C, TC Type K		-60 to +300 °C	Class 2	3 s	0602 0993
Flat head surface probe with telescopic handle max. 680 mm for measurements at hard-to-access points, TC Type K		-50 to +250 °C	Class 2	3 s	0602 2394
		Conn.: Fixed cable, 1.6 m (correspondingly shorter when telescope extended)			
Magnetic probe, adhesive force approx. 20 N, with magnets, for measurements on metal surfaces, TC Type K		-50 to +170 °C	Class 2		0602 4792
Magnetic probe, adhesive force approx. 10 N, with magnets, for higher temp., for measurements on metal surfaces, TC Type K		-50 to +400 °C	Class 2		0602 4892
Waterproof surface probe with widened measurement tip for flat surfaces, T/C Type K		-60 to +400 °C	Class 2	30 s	0602 1993
Pipe wrap probe with Velcro strip, for temperature measurement on pipes with diameter up to max. 120 mm, Tmax +120°C, TC Type K		-50 to +120 °C	Class 1	90 s	0628 0020
Pipe wrap probe for pipe diameter 5 to 65 mm, with exchangeable measuring head. Meas. range short-term to +280°C, TC Type K		-60 to +130 °C	Class 2	5 s	0602 4592
Spare meas. head for pipe wrap probe, TC Type K		-60 to +130 °C	Class 2	5 s	0602 0092
Clamp probe for measurements on pipes, pipe diameter 15 to 25 mm (max. 1"), meas. range short-term up to +130°C, TC Type K		-50 to +100 °C	Class 2	5 s	0602 4692
Immersion/penetr. probes	Illustration	Meas. range	Accuracy	t99	Part no.
Immersion tip, flexible, TC Type K		-200 to +1000 °C	Class 1	5 s	0602 5792
Flexible, low-mass immersion measurement tip, ideal for measurements in small volumes such as petri dishes, or for surface measurements (e.g. attached with adhesive tape), TC Type K		-200 to +1000 °C	Class 1	1 s	0602 0493
		Conn.: 2 m, FEP insulated thermal wire, temperature proof up to 200 °C, oval wire with dimensions: 2.2 mm x 1.4 mm			
Waterproof immersion/penetration probe, TC Type K		-60 to +400 °C	Class 2	7 s	0602 1293
Thermocouples	Illustration	Meas. range	Accuracy	t99	Part no.
Thermocouple with TC adapter, flexible, 800mm long, fibre glass, TC Type K		-50 to +400 °C	Class 2	5 s	0602 0644
Thermocouple with TC adapter, flexible, 1500mm long, fibre glass, TC Type K		-50 to +400 °C	Class 2	5 s	0602 0645
Thermocouple with TC adapter, flexible, 1500mm long, PTFE, TC Type K		-50 to +250 °C	Class 2	5 s	0602 0646

The measuring instrument inside TopSafe is waterproof with this probe.



## Option: Radio / Technical data

### Radio module for upgrading measuring instrument with radio option

Country versions	Radio freq.	Part no.
Radio module for measuring instrument, 869.85 MHz, approval for the countries: DE, FR, UK, BE, NL, ES, IT, SE, AT, DK, FI, HU, CZ, PL, GR, CH, PT, SI, MT, CY, SK, LU, EE, LT, IE, LV, NO	869.85 MHz FSK	0554 0188
Radio module for measuring instrument, 915.00 MHz FSK, approval for USA, CA, CL	915.00 MHz FSK	0554 0190

### Radio probes for immersion/penetration measurements

Radio immersion/penetration probes	Meas. range	Accuracy	Resolution	t <sub>99</sub>
Radio immersion/penetration probe, NTC 	-50 to +275 °C	±0.5 °C (-20 to +80 °C) ±0.8 °C (-50 to -20.1 °C) ±0.8 °C (+80.1 to +200 °C) ±1.5 °C (remaining range)	0.1 °C	t <sub>99</sub> (in water) 12 s

Country versions	Radio freq.	Part no.
Radio immersion/penetration probe, NTC, approval for the countries: DE, FR, UK, BE, NL, ES, IT, SE, AT, DK, FI, HU, CZ, PL, GR, CH, PT, SI, MT, CY, SK, LU, EE, LT, IE, LV, NO	869.85 MHz FSK	0613 1001
Radio immersion/penetration probe, NTC, approval for USA, CA, CL	915.00 MHz FSK	0613 1002

### Assembled for you: Radio handles with probe head

Radio handles with probe head for air-/ immersion-penetration-meas.	Meas. range	Accuracy	Resolution	t <sub>99</sub>
Radio handle for attachable probe heads with T/C probe head for air and immersion/penetration measurement 	-50 to +350 °C Short-term to +500 °C	Radio handle: ±(0.5 °C +0.3% of mv) (-40 to +500 °C) ±(0.7 °C +0.5% of mv) (remaining range) T/C probe head: Class 2	0.1 °C (-50 to +199.9 °C) 1.0 °C (remaining range)	t <sub>99</sub> (in water) 10 s

Country versions	Radio freq.	Part no.
Radio handle for plug-in probe heads, incl. T/C adapter, approval for the countries: DE, FR, UK, BE, NL, ES, IT, SE, AT, DK, FI, HU, CZ, PL, GR, CH, PT, SI, MT, CY, SK, LU, EE, LT, IE, LV, NO	869.85 MHz FSK	0554 0189
T/C probe head for air/immersion/penetration measurement, attachable to radio handle, T/C Type K		0602 0293
Radio handle for plug-in probe heads, incl. T/C adapter, approval for USA, CA, CL	915.00 MHz FSK	0554 0191
T/C probe head for air/immersion/penetration measurement, attachable to radio handle, T/C Type K		0602 0293

Radio handles with probe head for surface measurement	Meas. range	Accuracy	Resolution	t <sub>99</sub>
Radio handle for attachable probe heads with T/C probe head for surface measurement 	-50 to +350 °C Short-term to +500 °C	Radio handle: ±(0.5 °C +0.3% of mv) (-40 to +500 °C) ±(0.7 °C +0.5% of mv) (remaining range) T/C probe head: Class 2	0.1 °C (-50 to +199.9 °C) 1.0 °C (remaining range)	5 s

Country versions	Radio freq.	Part no.
Radio handle for plug-in probe heads, incl. T/C adapter, approval for the countries: DE, FR, UK, BE, NL, ES, IT, SE, AT, DK, FI, HU, CZ, PL, GR, CH, PT, SI, MT, CY, SK, LU, EE, LT, IE, LV, NO	869.85 MHz FSK	0554 0189
T/C probe head for surface measurement, attachable to radio handle, T/C Type K		0602 0394
Radio handle for plug-in probe heads, incl. T/C adapter, approval for USA, CA, CL	915.00 MHz FSK	0554 0191
T/C probe head for surface measurement, attachable to radio handle, T/C Type K		0602 0394

### Radio handles, separate

Radio handles for attachable T/C probes	Meas. range	Accuracy	Resolution
Radio handle for attachable probe heads incl. adapter for attaching T/C probes (Type K) 	-50 to +1000 °C	±(0.7 °C +0.3% of mv) (-40 to +900 °C) ±(0.9 °C +0.5% of mv) (remaining range)	0.1 °C (-50 to +199.9 °C) 1.0 °C (remaining range)

Country versions	Radio freq.	Part no.
Radio handle for plug-in probe heads, incl. T/C adapter, approval for the countries: DE, FR, UK, BE, NL, ES, IT, SE, AT, DK, FI, HU, CZ, PL, GR, CH, PT, SI, MT, CY, SK, LU, EE, LT, IE, LV, NO	869.85 MHz FSK	0554 0189
Radio handle for plug-in probe heads, incl. T/C adapter, approval for USA, CA, CL	915.00 MHz FSK	0554 0191

### Radio probes: General technical data

	Radio immersion/penetration probe, NTC	Radio handle	Measuring rate	Radio transmission	Unidirectional
Battery type	2 x 3V button cell (CR 2032)	2 AAA micro batteries	0.5 s or 10 s, adjustable on handle	Radio transmission	Unidirectional
Battery life	150 h (meas. rate 0.5 s) 2 months (meas. rate 10 s)	215 h (meas. rate 0.5 s) 6 months (meas. rate 10 s)			
			Radio coverage	Oper. temp.	-20 to +50 °C
			Up to 20 m (without obstructions)	Storage temp.	-40 to +70 °C
				Protection class	IP54

### Technical data testo 922 / testo 925

Probe type	Type K (NiCr-Ni)	Storage temp.
Meas. range	-50 to +1000 °C	-40 to +70 °C
Accuracy	±(0.5 °C +0.3% of mv) (-40 to +900 °C) ±1 digit ±(0.7 °C +0.5% of mv) (remaining range)	Battery type
Resolution	0.1 °C (-50 to +199.9 °C) 1 °C (remaining range)	9V block battery, 6F22
Oper. temp.	-20 to +50 °C	Battery life
		200 h (connected probe, backlight off) 45 h (radio mode, backlight off) 68 h (connected probe, backlight always on) 33 h (radio mode, backlight always on)
		Dimensions
		182 x 64 x 40 mm
		Weight
		171 g

## Temperature monitoring – Highly accurate

### testo 110

The highly accurate, versatile testo 110 temperature measuring instrument is ideal for the refrigeration sector on account of its optional TopSafe protection case. The engineering used is specially designed for applications in refrigerated store rooms and cabinets and for outdoors.

In addition to the wide range of conventional probes available with cable, a wireless radio probe can be used simultaneously (if radio module is used in instrument).

- Wireless measurement with radio probes possible (optional)
- Audible alarm (adjustable alarm limits)
- Displays max/min readings in 2 line, backlit display



Measurement data printout on site on Testo fast printer (optional)



Inspects a refrigerated counter for sufficient refrigeration power



TopSafe, the indestructible protective case (optional)



Monitors temperature in a freezing compartment using a wireless probe

### testo 110

testo 110, 1 channel temperature measuring instrument NTC, audible alarm, battery and calibration protocol included

Part no. 0560 1108

Printer and Accessories	Part no.
Testo fast printer with wireless infrared interface, 1 roll thermal paper and 4 AA batteries	0554 0549
Spare thermal paper for printer (6 rolls), measurement data documentation legible for up to 10 years	0554 0568
Spare thermal paper for printer (6 rolls)	0554 0569
External fast charger for 1-4 AA rech. batteries, incl. 4 Ni-MH rech. batteries with individual cell charging and charge control display, incl. impulse trickle charging, integrated discharge function, with built-in international mains plug, 100-240 V, 300 mA, 50/60 Hz	0554 0610
Additional accessories	Part no.
9V rech. battery for instrument, instead of battery	0515 0025
Recharger for 9V rechargeable battery, for external recharging of 0515 0025 battery	0554 0025
Transport and Protection	Part no.
TopSafe, protects from impact and dirt	0516 0221
Case for measuring instrument and probes	0516 0210
Transport case for meas. instr. and probes (405 x 170 x 85 mm)	0516 0201
Transport case for measuring instrument, 3 probes and accessories (430 x 310 x 85 mm)	0516 0200
Calibration Certificates	Part no.
ISO calibration certificate/temperature, for air/immersion probes, calibration points -18°C; 0°C; +60°C	0520 0001
ISO calibration certificate/temperature, single point calibration for surface thermometer; calibration point +60°C	0520 0072
ISO calibration certificate/temperature, single point calibration for surface thermometer; calibration point +120°C	0520 0073
DKD calibration certificate/temperature, meas. instr. with air/immersion probe; calibration points -20°C; 0°C; +60°C	0520 0211

### Recommended Set: testo 110 – Starter Set





testo 110, 1 channel temperature measuring instrument NTC, audible alarm, battery and calibration protocol included	0560 1108
TopSafe, protects from impact and dirt	0516 0221
Waterproof NTC immersion/penetration probe	0613 1212
Transport case for meas. instr. and probes (405 x 170 x 85 mm)	0516 0201

### Technical data

Probe type	NTC	NTC high temperature probe
Meas. range	-50 to +150 °C	0 to +275 °C
Accuracy	±0.2 °C (-20 to +80 °C) ±1 digit ±0.3 °C (remaining range)	±0.2 °C (0 to +80 °C) ±0.3 °C (remaining range)
Resolution	0.1 °C	0.1 °C
Oper. temp.	-20 to +50 °C	
Storage temp.	-40 to +70 °C	
Battery type	9V block battery, 6F22	
Battery life	200 h (connected probe, backlight off) 45 h (radio mode, backlight off) 68 h (connected probe, backlight always on) 33 h (radio mode, backlight always on)	
Dimensions	182 x 64 x 40 mm	
Weight	171 g	

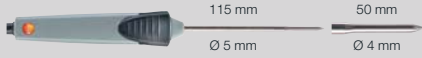
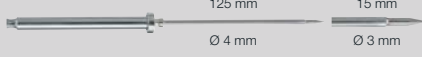
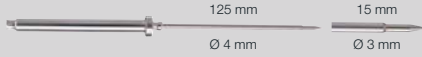
\* TopSafe: TPU casing; TPE lid; PC stand

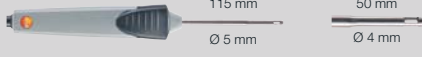
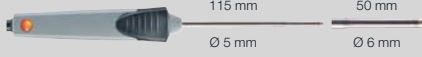
## Suitable probes at a glance / Option: Radio

Immers./penetr. probes	Illustration	Meas. range	Accuracy	t <sub>99</sub>	Part no.
Waterproof NTC immersion/penetration probe, Connection: fixed cable 1.2 m	 115 mm 50 mm Ø 5 mm    Ø 4 mm	-50 to +150 °C <sup>2)</sup>	±0.5% of mv (+100 to +150 °C) ±0.2 °C (-25 to +74.9 °C) ±0.4 °C (remaining range)	10 s	0613 1212
Stainless steel NTC food probe (IP65) with PUR cable, Connection: fixed cable 1.6 m	 125 mm 15 mm Ø 4 mm    Ø 3 mm	-50 to +150 °C <sup>2)</sup>	±0.5% of mv (+100 to +150 °C) ±0.2 °C (-25 to +74.9 °C) ±0.4 °C (remaining range)	8 s	0613 2211
Stainless steel NTC food probe (IP67) with PTFE cable to +250°C	 125 mm 15 mm Ø 4 mm    Ø 3 mm	-50 to +150 °C <sup>2)</sup>	±0.5% of mv (+100 to +150 °C) ±0.2 °C (-25 to +74.9 °C) ±0.4 °C (remaining range)	8 s	0613 3311
Robust NTC food penetration probe with special handle, reinforced PUR cable	 115 mm Ø 5 mm    30 mm Ø 3.5 mm	-25 to +150 °C <sup>2)</sup>	±0.5% of mv (+100 to +150 °C) ±0.2 °C (-25 to +74.9 °C) ±0.4 °C (remaining range)	7 s	0613 2411
Frozen food probe NTC, corkscrew design (incl. plug-in wire)	 110 mm Ø 8 mm    30 mm Ø 4 mm	-50 to +140 °C <sup>1)</sup>	±0.5% of mv (+100 to +140 °C) ±0.2 °C (-25 to +74.9 °C) ±0.4 °C (remaining range)	20 s	0613 3211
<b>Air probes</b>	<b>Illustration</b>	<b>Meas. range</b>	<b>Accuracy</b>	<b>t<sub>99</sub></b>	<b>Part no.</b>
Efficient, robust NTC air probe	 115 mm 50 mm Ø 5 mm    Ø 4 mm	-50 to +125 °C <sup>2)</sup>	±0.2 °C (-25 to +80 °C) ±0.4 °C (remaining range)	60 s	0613 1712
<b>Surface probes</b>	<b>Illustration</b>	<b>Meas. range</b>	<b>Accuracy</b>	<b>t<sub>99</sub></b>	<b>Part no.</b>
Waterproof NTC surface probe for flat surfaces	 115 mm 50 mm Ø 5 mm    Ø 6 mm	-50 to +150 °C <sup>2)</sup>	±0.5% of mv (+100 to +150 °C) ±0.2 °C (-25 to +74.9 °C) ±0.4 °C (remaining range)	35 s	0613 1912
Pipe wrap probe with Velcro for pipe diameter to max. 75 mm, T <sub>max.</sub> +75°C, NTC	 300 mm	-50 to +70 °C	±0.2 °C (-25 to +70 °C) ±0.4 °C (-50 to -25.1 °C)		0613 4611

 The measuring instrument inside TopSafe is waterproof with this probe.

1) Long-term meas. range +125 °C, short-term +140 °C  
2) Long-term meas. range +125 °C, short-term +150 °C

### Radio module for upgrading measuring instrument with radio option

Country versions	Radio freq.	Part no.
Radio module for measuring instrument, 869.85 MHz, approval for the countries: DE, FR, UK, BE, NL, ES, IT, SE, AT, DK, FI, HU, CZ, PL, GR, CH, PT, SI, MT, CY, SK, LU, EE, LT, IE, LV, NO	869.85 MHz FSK	0554 0188
Radio module for measuring instrument, 915.00 MHz FSK, approval for USA, CA, CL	915.00 MHz FSK	0554 0190

### Radio probes for immersion/penetration measurements

Radio immersion/penetration probes	Meas. range	Accuracy	Resolution	t <sub>99</sub>
Radio handle for attachable probe heads with T/C probe head for surface measurement	 105 mm 30 mm Ø 5 mm    Ø 3.4 mm	-50 to +275 °C	±0.5 °C (-20 to +80 °C) ±0.8 °C (-50 to -20.1 °C) ±0.8 °C (+80.1 to +200 °C) ±1.5 °C (remaining range)	0.1 °C t <sub>99</sub> (in water) 12 s
<b>Country versions</b>	<b>Radio freq.</b>	<b>Part no.</b>		
Radio immersion/penetration probe, NTC, approval for the countries: DE, FR, UK, BE, NL, ES, IT, SE, AT, DK, FI, HU, CZ, PL, GR, CH, PT, SI, MT, CY, SK, LU, EE, LT, IE, LV, NO	869.85 MHz FSK	0613 1001		
Radio immersion/penetration probe, NTC, approval for USA, CA, CL	915.00 MHz FSK	0613 1002		

### Radio probes: General technical data

	Radio immersion/penetration probe, NTC	Radio handle	Measuring rate	Radio transmission	Unidirectional
Battery type	2 x 3V button cell (CR 2032)	2 AAA micro batteries	0.5 s or 10 s, adjustable on handle		
Battery life	150 h (meas. rate 0.5 s) 2 months (meas. rate 10 s)	215 h (meas. rate 0.5 s) 6 months (meas. rate 10 s)	Radio coverage	Oper. temp.	-20 to +50 °C
			Up to 20 m (without obstructions)	Storage temp.	-40 to +70 °C
				Protection class	IP54



## Temperature Measurement, Accurate and Super-Fast

### testo 905-T2

The surface thermometer in professional quality with sprung thermocouple measuring head, very fast reaction time and high accuracy

- Very fast reaction time
- High accuracy
- Very simple to operate
- Auto-Off function

#### testo 905-T2

testo 905-T2: surface thermometer with cross-band probe, incl. attachment clip, battery

Part no. 0560 9056

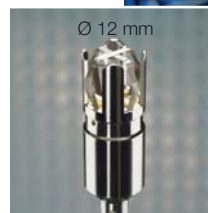

testo 905-T2: sprung thermocouple cross-band Ø 12 mm adapts to any surface



Easy readout of readings due to rotatable display



Monitoring temperature in a refrigeration system

#### Technical data

Meas. range	-50 to +350 °C Short-term to +500 °C		
Accuracy ±1 digit	±(1 °C ±1% of mv)		
Resolution	0.1 °C	Battery life	1000 h
Oper. temp.	0 to +40 °C	Storage temp.	-20 to +70 °C

#### Accessories

ISO calibration certificate/temperature, meas. instr. with surface probe; calibration points +60°C; +120°C; +180°C

#### Part no.

0520 0071

## Temperature Measurement, Accurate and Super-Fast

### Mini penetration thermometers

The quick-action immersion/penetration thermometer is ideal for measuring the temperature in air, soft or powdery substances and liquids.

- Easy to read thanks to large display

#### Mini penetration thermometers

1

Mini thermometer, 133 mm long, up to +150°C

Part no. 0560 1110

#### Mini penetration thermometers

2

Mini thermometer, 213 mm long, up to +150°C

Part no. 0560 1111

#### Mini penetration thermometers

3

Water-proof mini thermometer

Part no. 0560 1112



Measurements on air conditioning units

Technical data	1	2	3
Meas. range	-50 to +150 °C	-50 to +250 °C	-40 to +230 °C
Accuracy ±1 digit	±1 °C (-10 to +99.9 °C) ±2 °C (-30 to -10.1 °C) ±2% of mv (+100 to +150 °C)	±1 °C (-10 to +99.9 °C) ±2% of mv (+100 to +199.9 °C) ±3% of mv (+200 to +250 °C)	±1 °C (-20 to +99.9 °C) ±2% of mv (+100 to +199.9 °C) ±3% of mv (+200 to +230 °C)
Resolution	0.1 °C (-19.9 to +150 °C) 1 °C (remaining range)	0.1 °C (-19.9 to +199.9 °C) 1 °C (remaining range)	0.1 °C (-19.9 to +199.9 °C) 1 °C (remaining range)
Oper. temp.	-10 to +50 °C		

#### Accessories

Button cell batteries, Type LR 44, 1.5 Volt (4 off)

#### Part no.

0515 0032

## Non-contact temperature measurement on large surfaces (10:1 optics)

### testo 830-T1

The fast infrared thermometer with 1-point laser sighting. The 10:1 optics are ideal for temperature measurements on large surfaces

- 10:1 optics
- Display of current value and Hold value
- Emissivity adjustable from 0.2 to 1.0
- Audible and optical alarm when limit values are exceeded
- Fast measurement value recording at two measurements per second

#### testo 830-T1

Infrared thermometer with 1 point laser sighting, adjustable limit values and alarm function, incl. batteries

Part no. 0560 8301

### testo 830-T4

The versatile infrared thermometer with 30:1 optics allows temperature measurement at a safe distance from the measurement object. The diameter of the measurement point at a distance of 1 m is only 3.6 mm. The 2-point laser sighting avoids the measurement of undesired areas outside the measurement object.

Additional benefits:

- 30:1 optics for measuring temperature at a distance, even on small objects
- 2-point laser for spot sighting

#### testo 830-T4

IR temperature measuring instrument with 30:1 optics and 2-point laser measurement spot sighting, incl. battery and factory calibration certificate with the meas. points +80 °C and +350 °C

Part no. 0560 8304

testo 830-T4: Emissivity determination with external temperature probe



Large, backlit display

Non-contact temperature monitoring on a pipe with testo 830-T4. Two laser beams mark the measurement point

#### Set testo 830-T4

testo 830-T4 set, consisting of testo 830-T4 with protective leather case, incl. cross-band surface probe, battery and factory calibration certificate with the measurement points +80 °C and +350 °C

Part no. 0563 8304



Technical data	testo 830-T4	testo 830-T1	Common data
	<b>Infrared thermometer</b>	<b>Contact measurement (Type K)</b>	<b>Infrared thermometer</b>
Meas. range	-30 to +400 °C	-50 to +500 °C	-30 to +400 °C
Accuracy ±1 digit at +23 °C ambient temperature	±1,5 °C (-20 to 0 °C) ±2 °C (-30 to -20,1 °C) ±1 °C or 1% of mv (remaining range)	±0,5 °C +0,5% of mv	±1,5 °C or 1,5 % of mv (+0,1 to +400 °C) ±2 °C or ±2 % of mv (-30 to 0 °C)
Resolution	0,1 °C		0,5 °C
Optical resolution D:S	30:1 (typical at a distance of 0.7 m to the measurement object) 24 mm @ 700 mm (90 %)		10:1
			Measuring rate 0,5 s
			Oper. temp. -20 to +50 °C
			Storage temp. -40 to +70 °C
			Emissivity Adjustable 0.2 to 1.0
			Spectral range 8 to 14 µm
			Battery type 9V block battery
			Battery life 15 h
			Dimensions 190 x 75 x 38 mm

Accessories for testo 830-T1 and T4	Part no.
Adhesive tape, e.g. for bare surfaces (roll, L.: 10 m, W.: 25 mm), E = 0.95, temperature resistant to +250 °C	0554 0051
Leather case to protect measuring instrument, including belt holder	0516 8302
ISO calibration certificate/temperature, infrared thermometer; calibration points +60°C; +120°C; +180°C	0520 0002

Accessories for testo 830-T4 only	Part no.
Fast-action surface probe with sprung thermocouple strip, also for uneven surfaces, measurement range short-term to +500°C, TC Type K	0602 0393
ISO calibration certificate/temperature, meas. instr. with surface probe; calibration points +60°C; +120°C; +180°C	0520 0071

#### testo 830-T1, 1 point laser sighting

##### 10:1 standard optics

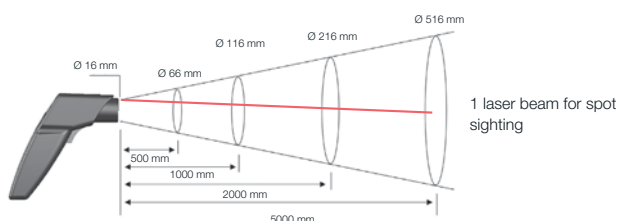

#### testo 830-T4, 2-point laser for spot sighting

##### 30:1 optics

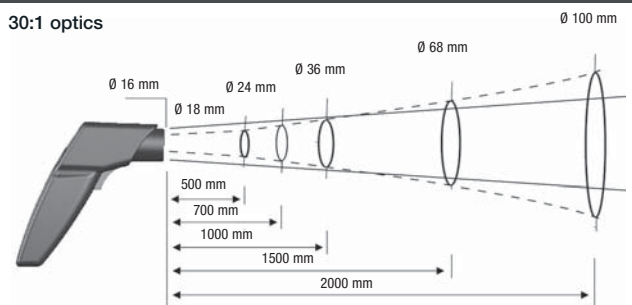





## testo 845 – the infrared measurement technology for temperature with integrated humidity module

The testo 845 is a milestone in non-contact temperature measurement. For the first time, surface temperatures with smallest diameters can be measured accurately at short and long distances. The switchable optics for far-field and close focus measurement make this possible.

testo 845 is equipped with an optical resolution of 75:1 for far-field measurements. Surface temperatures can be measured accurately even at great distances from the object to be measured. At a distance of 1.2 metres from the object to be measured, the measuring spot diameter is only 16 mm. A cross laser marks the measuring spot exactly during measurement. Incorrect measurements are eliminated - you always know exactly where you are measuring.

The close focus optics allow the measurement of temperatures on the smallest surfaces with a diameter of just 1 mm and a distance of 70 mm! Two lasers mark the measuring spot exactly.

- Switchable optics for far-field measurements (75:1) and close focus (1 mm, 70 mm distance)
- Especially bright cross laser sighting for indicating the actual measuring point
- Reference accuracy  $\pm 0.75\text{ }^{\circ}\text{C}$  with super-fast measurement technology (scanning 100 ms)
- Backlit display (3-line), shows  $^{\circ}\text{C}$ , min./max. values, alarm limit values and emissivity; in addition display with humidity module: %RH,  $^{\circ}\text{Ctd}$
- Optical and audible alarm when limit values are exceeded
- Instrument memory for 90 measurement protocols
- PC software for archiving and documenting measurement data (included in delivery)
- Tripod fitting for online measurement via USB cable (included in delivery)



Switch optics 1:  
Far-field 75:1 (16 mm,  
distance 1200 mm) with  
cross laser sighting



Switch optics 2:  
close focus (1 mm, dis-  
tance 70 mm) with 2-  
point laser sighting



testo 845 with additional hu-  
midity module for measuring  
ambient air humidity and for  
determining dewpoint dis-  
tance



Fast documentation with  
measurement data prin-  
tout on site



## Infrared Thermometer with Switchable Optics (far-field/close focus)

### testo 845

testo 845, infrared temperature measuring instrument with cross-laser sighting, switchable optics for far-field and close focus measurement, contact temperature probe attachable, optical/audible alarm, reading memory, PC software incl. USB data transfer cable, aluminium case, battery and calibration protocol

Part no. 0563 8450

### testo 845 with integrated humidity module

testo 845, infrared temperature measuring instrument with cross laser sighting incl. humidity module, switchable optics for far-field and close focus measurement, contact temperature probe attachable, optical/audible alarm, reading memory, PC software incl. USB data transfer cable, aluminium case, battery and calibration protocol

Part no. 0563 8451

Description	Meas. range	Part no.
Fast-action surface probe with sprung thermocouple strip, also for uneven surfaces, measurement range short-term to +500°C, TC Type K	-60 to +300 °C	0602 0393
		115 mm Ø 5 mm
Robust air probe, T/C Type K	-60 to +400 °C	0602 1793
		115 mm Ø 4 mm

Accessories Ordering data	Part no.
Humidity module, upgradeable for testo 845 (0563 8450)	0636 9784
Plug-in mains adapter, 5 VDC 500 mA with European adapter, 100-250 VAC, 50-60 Hz	0554 0447
External fast charger for 1-4 AA rech. batteries, incl. 4 Ni-MH rech. batteries with individual cell charging and charge control display, incl. impulse trickle charging, integrated discharge function, with built-in international mains plug, 100-240 V, 300 mA, 50/60 Hz	0554 0610
Testo fast printer with wireless infrared interface, 1 roll thermal paper and 4 AA batteries, for printing out measurements on site	0554 0549
Spare thermal paper for printer (6 rolls), measurement data documentation legible for up to 10 years	0554 0568
testo saline pots for control and humidity adjustment of humidity probes, 11.3 %RH and 75.3 %RH with adapter for humidity probe, quick checks or calibration of humidity probe	0554 0660
Adhesive tape, e.g. for bare surfaces (roll, L.: 10 m, W.: 25 mm), E = 0.95, temperature resistant to +250 °C	0554 0051
Silicone heat paste (14g), Tmax = +260°C, improves heat transfer in surface probes	0554 0004
ISO calibration certificate/temperature, infrared thermometer; calibration points +60°C; +120°C; +180°C	0520 0002
ISO calibration certificate/temperature, Infrared thermometers, calibration points -18°C, 0°C, +60°C	0520 0401

### Far-field measurement

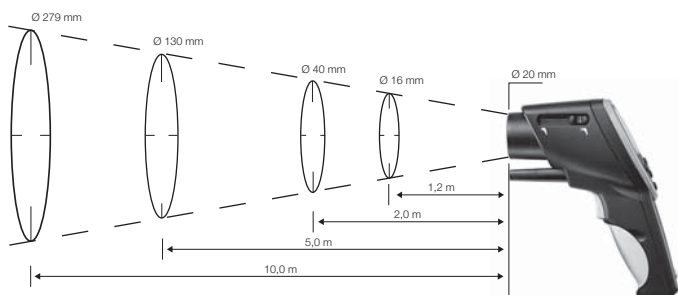

Measurement point diameter and distance to measurement field



Probe socket for TC probes for determining emissivity

Aluminium case (405 x 340 x 93 mm) for measuring instrument and accessories (included in delivery)

Monitoring the temperature on ventilation ducts

Technical data			
Probe type	Infrared	Contact (Type K)	
Meas. range	-35 to +950 °C	-35 to +950 °C	
Accuracy	±2.5 °C (-35 to -20.1 °C) ±1.5 °C (-20 to +19.9 °C) ±0.75 °C (+20 to +99.9 °C) ±0.75% of mv (+100 to +950 °C)	±0.75 °C (-35 to +75 °C) ±1% of mv (+75.1 to +950 °C)	
Resolution	0.1 °C	0.1 °C	
Probe type	Humidity module		
Meas. range	0 to +100 %RH	0 to +50 °C	-20 to +50 °C td
Accuracy	±2 %RH (2 to 98 %RH) ±1 digit	±0.5 °C (+10 to +40 °C) ±1 °C (remaining range)	
Resolution	0.1 %RH	0.1 °C	0.1 °C td
Spectral range	8 to 14 µm		
Emission factor	Adjustable 0.1 to 1.0		
Optical resolution	Far-field (75:1): 16 mm @ 1200 mm (90%) Near-field (close focus): 1 mm @ 70 mm (90%)		
Measurement rate	t95: 250 ms; Scanning Max/Min/Alarm: 100 ms		
Dimensions	155 x 58 x 195 mm		
Voltage supply	2 x AA AIMn or via USB		
Battery life	25 h (without laser), 10 h (with laser without light), 5 h (with laser and 50% light)		
Material/Housing	ABS black/gray, metal screen		
Oper. temp.	-20 to +50 °C	Weight	465 g
Storage temp.	-40 to +70 °C		

### Close focus measurement

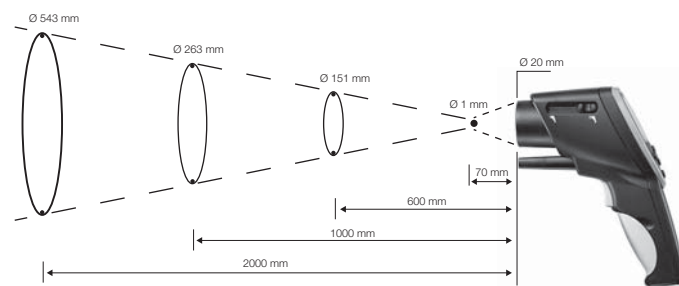

Measurement point diameter and distance to measurement field

## Flexible fiberscope for fast diagnoses

### testo 319

The testo 319 fibre-glass fiberscope facilitates easy inspections at difficult-to-access points such as in air ducts, ventilators, machines and motors etc. Diagnoses such as corrosion, friction wear, condition of welding joints, loose parts and lots more can be made very early, very quickly and very easily using endoscopy.

The flexible testo 319 can be guided through hollow spaces, bore holes and bends. You can adjust the focus using the focussing wheel. In this way the damaged point can be appraised without the need for dismantling.

- Optics: 6,000 pixels with a field of view of 50°
- Low bending radius (50 mm), small diameter (6 mm)
- Stability thanks to Decabon pipe
- Gooseneck casing for medium flexibility
- 3-arm gripper: Grips small objects (optional)



LED light, high contrast display

Inspects air duct, with gooseneck casing, middle flexibility



Checks insulations by using the stability of the Decabon tube

#### testo 319

testo 319 fiberscope

Part no. 0632 3191

#### testo 319 set

Fiberscope set, consisting of testo 319 fiberscope, gooseneck tube, magnet and mirror attachments, bag

Part no. 0563 3191

Accessories Ordering data	Part no.
Flexible push-on gooseneck tube,	0554 3196
Decabon push-on tube	0554 3191
Two-channel push-on hose	0554 3190
Magnet attachment	0554 3195
Mirror attachment 45° angle	0554 3194
Temperature probe for two-channel hose	0554 3193
3-arm gripper, for two-channel hose	0554 3192
Bag for basic set testo 319, gooseneck tube, magnet and mirror attachment	0516 3192

#### Technical data

No. of pixels:	6,000
Fibre-optic field of view:	50°
Angle of field of view:	45° +/- 5°
Min. focus distance:	15 mm (close)
Max. focus distance:	150 mm (light)
Operating and storage temperature:	-20° to + 60°C
Working temperature/Probe:	-20° to + 80°C
Probe diameter:	6.5 mm
Probe length:	1247 mm +/- 6
Max. bending radius:	50 mm
Light source:	LED 2 point light
Battery life:	Typically 50,000 h
Probe resistance:	Probe tip water-proof up to handle
	Short-term resistance to silicone oils, petrol and kerosene. Oils or petrol must be wiped off immediately after immersion
Housing:	Black
Battery type:	3 AA Mignon 1.5 V
	Battery life: 4 h



## Sound level measuring instrument

### testo 815

The ideal instrument for daily use. Whether it is for air conditioning or heating, disco noise, machine noise or noise in combustion systems, testo 815 is the ideal partner.

#### Common features:

- Frequency weighting according to characteristic A and C
- Maximum and minimum value memory
- Built-in tripod knuckle screw (1/4 inch)
- Switchable time weighting Fast / Slow

#### testo 815

Sound level meter, incl. microphone, wind protection cap and battery

Part no. 0563 8155

### testo 816

Compared to testo 815, the larger model has additional features which make it ideal for assessors, workplace measurements and for measuring industrial and environmental noise.

#### Additional benefits of testo 816:

- Automatic range switchover
- Backlit display
- BarGraph display
- AC/DC output for connection to amplifiers, recorders or dataloggers

#### testo 816

Sound level meter, incl. microphone, wind protection cap, battery, stereo jack 3.5 mm, in a practical measurement case

Part no. 0563 8165



Frequency weighting of current reading  
Time weighting  
Section measurement range



testo 815, Monitoring measurements in ventilation



testo 816, Checking noise control

Accessories Ordering data	Part no.	
Calibrator, for regular calibration of testo 815, testo 816	0554 0452	
Mains unit 230 V/ 8 V/ 1 A, for instrument (European plug), for mains operation and battery recharging	0554 1084	
ISO calibration cert./sound pressure, calibration points 94 dB; 104 dB; 114 dB at different frequencies	0520 0111	
ISO calibration certificate sound pressure calibrators	0520 0411	
Technical data	testo 815	testo 816
Meas. range	+32 to +130 dB	+30 to +130 dB
Accuracy ±1 digit	±1.0 dB	±1.0 dB
Resolution	0.1 dB	0.1 dB
Battery life	70 h	50 h
Weight	195 g	315 g
Dimensions	255 x 55 x 43 mm	309 x 68 x 50 mm
Battery type	9V block battery	
Oper. temp.	0 to +40 °C	Storage temp. -10 to +60 °C
Other features	Section meas. ranges: 30 to 80 dB; 50 to 100 dB; 80 to 130 dB Time weighting: FAST 125 ms setting / SLOW 1 s setting Pressure dependency: -0.0016 dB/hPa	

## Rpm measurement

### testo 465

#### Non-contact

Using testo 465, rpm can be easily measured without contact. Simply attach a reflector to the object to be measured and then point the visible red light beam at the reflector and measure.

- Stores mean/min/max value, last reading
- Robust design on account of SoftCase (protection sleeve)

#### testo 465

Rpm measuring instrument set: Meas. instr. incl. SoftCase (protection sleeve) in transport case (plastic), reflectors, batteries and calibration protocol

Part no. 0563 0465

### testo 470

#### Non-contact and mechanical

The ideal combination of optical and mechanical rpm measurement. An optical measurement becomes a mechanical measurement by simply attaching an adapter for a probe tip or surface speed disc.

- Measures rpm, velocities and lengths
- Battery display "Low Batt"
- Robust design on account of SoftCase (protection sleeve)

#### testo 470

Rpm meas. instr. set: Meas. instr. incl. SoftCase (protection sleeve) in transport case, adapter, probe tip, surface speed disc, reflectors, batts and cal. protocol

Part no. 0563 0470



testo 470, mechanical rpm measurement



testo 465 and testo 470, non-contact (optical) rpm measurement on rotating parts

Technical data	Optically with mod. light beam	Mechanical (testo 470)
<b>Probe type</b>		
Meas. range	+1 to +99999 rpm	+1 to +19.999 rpm
Accuracy ±1 digit	±0.02% of mv	
Resolution	0.01 rpm (+1 to +99.99 rpm) 0.1 rpm (+100 to +999.9 rpm) 1 rpm (+1000 to +99999 rpm)	
Oper. temp.	0 to +50 °C	Dimensions 175 x 60 x 28 mm
Storage temp.	-20 to +70 °C	Weight 190 g
<b>testo 470</b>		
Speed: 0.10 to 33.3 m/s; 0.1 to 109 ft/s; 0.10 to 1.999 m/min; 0.40 to 6550 ft/min; 4.00 to 78,700 in/min		
Lengths: 0 to 99.999 m; 0 to 99.999 ft; 0 to 99.999 in		
Accuracy: (±1 digit/0.02 m/1.00 inch depending on resolution)		

Accessories Ordering data	Part no.
Reflectors, self-adhesive (1 pack = 5 off, each 150 mm long)	0554 0493
ISO calibration certificate/rpm, optical and mechanical rpm measuring instruments; cal. points 500; 1000; 3000 rpm	0520 0012
ISO calibration certificate/rpm, optical rpm measuring instruments; calibration points 10; 100; 1000; 10000; 99500 rpm	0520 0022

## Data loggers — For monitoring purposes

### What is the temperature really?



Wolfgang Schwörer, Head of Product Development Portable and Systems

How can you be sure that your analyser measures exactly what it should be measuring? Our certified DKD laboratories are unbeatable in their accuracy and provide the values for all

Testo measuring instruments - That's what true measurement efficiency is all about.

The competence of our engineers is held in high esteem by expert groups and committees in Berlin and Brussels where they are involved in the developments of future guidelines in their capacity as representatives of industry.

A comprehensive exchange of knowledge and experience with official measurement institutes around the world (e.g. DKD) ensures that your Testo measuring instrument can hold up to any comparison. Indeed, these efforts do have an objective: whoever uses Testo measurement engineering, can be assured that he is using the industrial standard.

Of further benefit to you: We know today about the guidelines and test specifications we will be faced with in the future.



On site: Fast printout on the testo 575 printer



testo 580 data collector collects and transmits data on site to PC



testo 581 alarm signal output for reliable warning of limits exceeded



Ethernet facilitates data communication in the network





## Pro Data Loggers for Long-Term Monitoring

### testo 177-T1

The professional testo 177-T1 data logger (without display) monitors specified storage and transport conditions in the refrigeration and deep-freeze sector efficiently and accurately over a period of months and years.

Temperature fluctuations which cause damage are documented on the testo 575 fast printer or analysed on your PC via interface.

### testo 177-T2

testo 177-T2, the professional data logger with display. It provides you with a quick overview of the current reading, the last value saved, max and min values and the number of times the limits were exceeded.

All of the values collected by the testo 580 data collector during long-term monitoring over months/years can be sent to your notebook/PC. Convenient analysis possible using software based on Windows®.

- Logs temperatures with up to 48,000 readings
- Specially for use in low temperatures (up to -40 °C)
- On-site: Fast documentation on the infrared printer, 6 lines/s
- Collect data on-site with testo 580 and download to your PC for analysis



testo 177-T1 without display, data is printed on site on the fast testo 575 printer



Collects data on site which is uploaded to your PC for analysis



Long-term temperature logging with immediate display of limits exceeded e.g. during transport, in refrigerated rooms, warehouses etc.

#### testo 177-T1 without display

Temperature data logger, 1 channel, with internal sensor, wall holder and calibration protocol (please order calibration certificates (DKD,350) separately)

**Part no. 0563 1771**

#### testo 177-T2 with display

Temperature data logger, 1 channel, with internal sensor, wall holder and calibration protocol (please order calibration certificates (DKD,350) separately)

**Part no. 0563 1772**

#### Recommended Set: testo 177-T1, Starter Set

Temperature data logger, 1 channel, with internal sensor, wall holder and calibration protocol (please order calibration certificates (DKD,350) separately)	0563 1771
Lock for wall holder for testo 175/177 data loggers	0554 1755
ComSoft 4 Set - Basic with USB interface, Basic software with diagram and table function, incl. desk-top holders, PC connection cable	0554 1767

#### Technical data

Chann. intern	1	Probe type	NTC
Meas. range	-40 to +70 °C	Resolution	0.1 °C
Accuracy ±1 digit	±0.4 °C (-25 to +70 °C)	±0.8 °C (-40 to -25.1 °C)	
Measuring rate	2 s to 24 h	Memory	48000
Oper. temp.	-40 to +70 °C	Storage temp.	-40 to +85 °C
Dimensions	103 x 64 x 33 mm		
Weight	111 g (testo 177-T1)	122 g (testo 177-T2)	
Battery life	5 years at meas. cycle of 15 min (-10 to +50 °C)		
Analysis software	MS Windows 95b / 98 / ME / NT4-Sp4 / 2000 / XP		

#### Recommended Set: testo 177-T2, Starter Set

Temperature data logger, 1 channel, with internal sensor, wall holder and calibration protocol (please order calibration certificates (DKD,350) separately)	0563 1772
Lock for wall holder for testo 175/177 data loggers	0554 1755
ComSoft 4 Set - Basic with USB interface, Basic software with diagram and table function, incl. desk-top holders, PC connection cable	0554 1767



## The data logger with 2 probe sockets and event logging

### testo 177-T3

testo 177-T3 documents 3 temperatures and an event simultaneously providing proof of an uninterrupted cooling chain during transport.

For example, complete monitoring of ambient air, intake and outgoing temperature with simultaneous monitoring of the door is possible when monitoring refrigerated store rooms. The measuring rate of the event can be set completely independently of the measuring rate of the temperature channels.

- Temperature logging of up to 48000 readings
- Data is read out without interrupting the measurement series
- Data analysis as table or graph, with Email function

#### testo 177-T3

##### Internal °C + 2 x external °C + event contact

Temperature data logger, 3 channels, with internal sensor, 2 probe sockets, door contact connection cable, wall holder and calibration protocol (please order calibration certificates (DKD,350) separately)

Part no. 0563 1773



Collect data on site, read out on your PC and analyse



Temperature monitoring at different sites e.g. during transport, in warehouses, in containers etc.

#### Technical data

Chann. intern 1		Chann. external (var.) 2	
Meas. range	-40 to +70 °C	Meas. range	-40 to +120 °C
Accuracy	±0.4 °C (-25 to +70 °C) ±1 digit	Accuracy	±0.2 °C (-25 to +70 °C) ±1 digit
Resolution	0.1 °C	Resolution	0.1 °C
Memory	48000	Battery type	Lithium battery
Oper. temp.	-40 to +70 °C	Weight	127 g
Storage temp.	-40 to +85 °C	Dimensions	103 x 64 x 33 mm

External: Event logging e.g. door contact  
 Battery life: 5 years with meas. rate of 15 min (-10 to +50°C)  
 Measuring rate: 2 s to 24 h  
 Software: Microsoft Windows 95b / 98 / ME / NT4-Sp4 / 2000 / XP / Vista

#### Recommended Set: Temperature monitoring with printout on-site

Temperature data logger, 3 channels, with internal sensor, 2 probe sockets, door contact connection cable, wall holder and calibration protocol (please order calibration certificates (DKD,350) separately)	0563 1773
Lock for wall holder for testo 175/177 data loggers	0554 1755
Stationary probe with aluminium sleeve, IP 65	0628 7503
Stationary probe with aluminium sleeve, IP 65	0628 7503
Fast testo 575 printer, incl. 1 roll of thermal paper and batteries	0554 1775
ComSoft 4 Set - Basic with USB interface, Basic software with diagram and table function, incl. desk-top holders, PC connection cable	0554 1767

See page 46 for Accessories Ordering Data

Description	Illustration	Meas. range	Accuracy	t99	Part no.
Stub probe, IP 54	35 mm Ø 3 mm	-20 to +70 °C	±0.2 °C (-20 to +40 °C) ±0.4 °C (+40.1 to +70 °C)	15 s	0628 7510
Stationary probe with aluminium sleeve, IP 65	40 mm Ø 6 mm	-30 to +90 °C	±0.2 °C (0 to +70 °C) ±0.5 °C (remaining range)	190 s	0628 7503*
Accurate imm./pen. probe, 6m cable, IP 67	40 mm Ø 3 mm	-35 to +80 °C	±0.2 °C (-25 to +74.9 °C) ±0.4 °C (remaining range)	5 s	0610 1725*
Accurate immersion/penetration probe, cable: 1.5 m long, IP 67					0628 0006*
Probe for surface measurement	40 mm 8 x 8 mm	-50 to +80 °C	±0.2 °C (0 to +70 °C)	150 s	0628 7516*
Stainless steel NTC food probe (IP65) with PUR cable	125 mm Ø 4 mm	-50 to +150 °C	±0.5% of mv (+100 to +150 °C) ±0.2 °C (-25 to +74.9 °C) ±0.4 °C (remaining range)	8 s	0613 2211*
Robust NTC food penetration probe with special handle, reinforced PUR cable	115 mm Ø 5 mm	-25 to +150 °C	±0.5% of mv (+100 to +150 °C) ±0.2 °C (-25 to +74.9 °C) ±0.4 °C (remaining range)	7 s	0613 2411*
Frozen food probe NTC, corkscrew design (incl. plug-in wire)	110 mm Ø 8 mm	-50 to +140 °C	±0.5% of mv (+100 to +140 °C) ±0.2 °C (-25 to +74.9 °C) ±0.4 °C (remaining range)	20 s	0613 3211*
Efficient, robust NTC air probe	115 mm Ø 5 mm	-50 to +125 °C	±0.2 °C (-25 to +80 °C) ±0.4 °C (remaining range)	60 s	0613 1712

ⓘ The specified seal class of the data loggers is achieved with these probes.

\* Probe tested to EN 12830 for suitability in the transport and storage sectors

# Professional long-term monitoring, data logger with 4 probe sockets

## testo 177-T4

The testo 177-T4 professional data logger with up to 4 external temperature probe connections for simultaneous temperature measurement at different sites.

Using testo 177-T4, refrigeration/freezer storage rooms can be monitored non-stop and the data saved on PC.

- Specially for use in high and low temperatures
- Read out data without interrupting the measurement series
- Data analysis in table or graphics form, with email function
- Memory for up to 48,000 readings



Collect data on site, upload to PC and analyse



Alarm message, efficient indication of limits exceeded



Simultaneous temperature measurement at up to 4 different sites

### testo 177-T4

#### 4 x external °C

Temperature data logger, 4 channel, with 4 probe sockets, wall holder and calibration protocol (please order calibration certificates (DKD,350) separately)

Part no. 0563 1774

#### Technical data

Chann. external (var.)	4		
Probe type	Type T (Cu-CuNi)	Type K (NiCr-Ni)	Type J (Fe-CuNi)
Meas. range	-200 to +400 °C	-200 to +1000 °C	-100 to +750 °C
Accuracy ±1 digit	±0.5% of mv (+70.1 to +1000 °C) ±1.5% of mv (-200 to -100.1 °C) ±0.3 °C (-100 to +70 °C)		
Resolution	0.1 °C		
Memory	48000	Measuring rate	2 s to 24 h
Oper. temp.	0 to +70 °C	Protection class	IP43
Storage temp.	-40 to +85 °C	Weight	129 g
Battery type	Lithium battery	Dimensions	103 x 64 x 33 mm
Battery life	5 years at meas. cycle 15 min (-10 to +50 °C)		
Analysis software	MS Windows 95b / 98 / ME / 2000 / XP / Vista		

See page 46 for Accessories Ordering Data

### Recommended Set: Set for monitoring technical systems

Temperature data logger, 4 channel, with 4 probe sockets, wall holder and calibration protocol (please order calibration certificates (DKD,350) separately)	0563 1774
Lock for wall holder for testo 175/177 data loggers	0554 1755
Pipe wrap probe for pipe diameter 5 to 65 mm, with exchangeable measuring head. Meas. range short-term to +280°C, TC Type K	0602 4592
Pipe wrap probe for pipe diameter 5 to 65 mm, with exchangeable measuring head. Meas. range short-term to +280°C, TC Type K	0602 4592
testo 580 data collector set with RS232, readout holders included, for testo 175/177 data loggers	0554 1778
ComSoft 4 Set - Basic with USB interface, Basic software with diagram and table function, incl. desk-top holders, PC connection cable	0554 1767

Description	Illustration	Meas. range	Accuracy	t99	Part no.
Stationary probe with stainless steel sleeve, TC Type K	40 mm Ø 6 mm	-50 to +205 °C	Class 2	20 s	0628 7533
Pipe wrap probe for pipe diameter 5 to 65 mm, with exchangeable measuring head. Meas. range short-term to +280°C, TC Type K		-60 to +130 °C	Class 2	5 s	0602 4592
Surface temperature probe fitting with M 14 x 1,5 outer thread and 2 nuts, fast action surface probe with cross-band, TC Type K		-50 to +180 °C	Class 2	3 s	0628 7521
Thermocouple with TC adapter, flexible, 800mm long, fibre glass, TC Type K	800 mm Ø 1.5 mm	-50 to +400 °C	Class 2	5 s	0602 0644
Thermocouple with TC adapter, flexible, 1500mm long, fibre glass, TC Type K	1500 mm Ø 1.5 mm	-50 to +400 °C	Class 2	5 s	0602 0645
Thermocouple with TC adapter, flexible, 1500mm long, PTFE, TC Type K	1500 mm Ø 1.5 mm	-50 to +250 °C	Class 2	5 s	0602 0646
Efficient and fast-action immersion probe, waterproof, TC Type K	300 mm Ø 1.5 mm	-60 to +1000 °C	Class 1	2 s	0602 0593

☐ The specified seal class of the data loggers is achieved with these probes.

## Monitor refrigerated rooms, efficiently and reliably

### testo 175-H1

The affordable humidity/temperature logger testo 175-H1, without display, monitors fluctuations in storage humidity and temperature efficiently and unobtrusively.

Limit values can be entered, an alarm display is activated if the limits are exceeded. testo 575, the fast printer, supplies proof of fluctuations in ambient conditions.

### testo 175-H2

The compact humidity/temperature logger with display. It provides you with a fast on-site overview of current readings, the last values saved, max and min values and the number of times limits were exceeded.

The testo 575 fast printer provides proof that specified ambient storage conditions or production conditions have been adhered to. All of the values logged by the testo 580 data collector can then be uploaded to your PC for analysis.

- Humidity sensor guaranteed long-term stable
- Memory for up to 3700 readings (testo 175-H1)
- Memory for up to 16000 readings (testo 175-H2)
- Data safe even when battery is spent
- Fast documentation on infrared printer, 6 lines/s
- Data transfer to PC or Notebook via interface or testo 580 data collector
- Large display (testo 175-H2)

#### testo 175-H1 w/o display

##### Internal %RH, °C

Humidity/temperature logger, 2 channels, with internal sensors, wall holder and calibration protocol (please order calibration certificates (DKD,350) separately)

Part no. 0563 1757

#### testo 175-H2 with display

##### Internal %RH, °C

Humidity/temperature logger, 2 channels, with built-in sensors, wall holder and calibration protocol (please order calibration certificates (DKD,350) separately)

Part no. 0563 1758

Technical data	testo 175-H1 w/o display	testo 175-H2 with display
Channels	2	2
Probe type	Testo humid. sensor, cap. NTC	Testo humid. sensor, cap. NTC
Meas. range	0 to +100 %RH* -10 to +50 °C	0 to +100 %RH* -20 to +70 °C
Accuracy ±1 digit	±3 %RH ±0.5 °C	±3 %RH ±0.5 °C
Resolution	0.1 %RH 0.1 °C	0.1 %RH 0.1 °C
Memory	3700	16000
Oper. temp.	-10 to +50 °C	-20 to +70 °C
Storage temp.	-40 to +70 °C	-40 to +85 °C
Weight	80 g	85 g
Dimensions	82 x 52 x 30 mm	82 x 52 x 30 mm
Battery life	2.5 years at a meas. rate of 15 min (-10 to +50 °C)	
Measuring rate	10 s to 24 h	10 s to 24 h
Software	MS Windows 95b / 98 / ME / 2000 / XP / Vista	

\* not affected by condensation



testo 175-H1 without display. Data is printed on the fast printer.



Data analysis with easy-to-use Windows® software



testo 175-H2, refrigerated room ambient conditions logging with immediate display of limits exceeded

#### Recommended Set: testo 175-H1, Starter Set

Humidity/temperature logger, 2 channels, with internal sensors, wall holder and calibration protocol (please order calibration certificates (DKD,350) separately)	0563 1757
Lock for wall holder for testo 175/177 data loggers	0554 1755
ComSoft 4 Set - Basic with USB interface, Basic software with diagram and table function, incl. desk-top holders, PC connection cable	0554 1766

#### Recommended Set: testo 175-H2, Starter Set

Humidity/temperature logger, 2 channels, with built-in sensors, wall holder and calibration protocol (please order calibration certificates (DKD,350) separately)	0563 1758
Lock for wall holder for testo 175/177 data loggers	0554 1755
ComSoft 4 Set - Basic with USB interface, Basic software with diagram and table function, incl. desk-top holders, PC connection cable	0554 1766

See Page 46 for Accessories Ordering Data



# Long-term refrigeration storage monitoring, professional and non-stop

## testo 177-H1

Sensitive products require the right ambient conditions in refrigerated rooms. Efficient measurement and documentation of the readings over months/years is possible using the testo 177-H1 professional data logger.

Additional surface, immersion and air probes can be attached to the data logger.

- Long-term stable humidity sensor with fast response time
- Memory for up to 48,000 readings

- Control and adjustment option with adjustment set
- Protective caps for dirt-ingressed air or corrosive gases

### testo 177-H1

**Intern. %RH, °C, °C td + extern. °C**  
Humidity/temperature logger, 4 channel, with internal sensors and an external temperature probe socket, wall holder and calibration protocol (please order calibration certificates (DKD,350) separately)  
**Part no. 0563 1775**



Collect data on site, upload to PC and analyse



Alarm message, reliable notification when limits are exceeded



Efficient measurement of storage conditions

### Technical data

<b>Chann. intern</b>	<b>3</b>		
Meas. range	0 to +100 %RH	-20 to +70 °C	-40 to +70 °C td
Accuracy ±1 digit	±2 %RH	±0.5 °C	
Resolution	0.1 %RH	0.1 °C	0.1 °C td
<b>Chann. external (var.)</b>	<b>1</b>		
Meas. range	-40 to +120 °C		
Accuracy ±1 digit	±0.2 °C (-25 to +70 °C)		±0.4 °C (remaining range)
Resolution	0.1 °C		
Memory	48000		
Measuring rate	2 s to 24 h	Protection class	IP54
Battery life	5 years at a meas. cycle of 15 min (-10 to +50 °C)		
Analysis software	MS Windows 95b / 98 / ME / 2000 / XP / Vista		
Oper. temp.	-20 to +70 °C	Storage temp.	-40 to +85 °C
Dimensions	103 x 64 x 33 mm	Weight	130 g

See Page 46 for Accessories Ordering Data

Description	Illustration	Meas. range	Accuracy	t99	Part no.
Stub probe, IP 54		-20 to +70 °C	±0.2 °C (-20 to +40 °C) ±0.4 °C (+40.1 to +70 °C)	15 s	0628 7510
Stationary probe with aluminium sleeve, IP 65		-30 to +90 °C	±0.2 °C (0 to +70 °C) ±0.5 °C (remaining range)	190 s	0628 7503*
Probe for surface measurement		-50 to +80 °C	±0.2 °C (0 to +70 °C)	150 s	0628 7516*
Stainless steel NTC food probe (IP65) with PUR cable		-50 to +150 °C Long-term meas. range +125 °C, short-term +150 °C (2-minute)	±0.5% of mv (+100 to +150 °C) ±0.2 °C (-25 to +74.9 °C) ±0.4 °C (remaining range)	8 s	0613 2211*
Robust NTC food penetration probe with special handle, reinforced PUR cable		-25 to +150 °C Long-term meas. range +125 °C, short-term +150 °C (2-minute)	±0.5% of mv (+100 to +150 °C) ±0.2 °C (-25 to +74.9 °C) ±0.4 °C (remaining range)	7 s	0613 2411*
Wall surface temperature probe, e.g. to prove damage in building material		-50 to +80 °C	±0.2 °C (0 to +70 °C)	20 s	0628 7507
Pipe wrap probe with Velcro for pipe diameter to max. 75 mm, Tmax. +75 °C, NTC		-50 to +70 °C	±0.2 °C (-25 to +70 °C) ±0.4 °C (-50 to -25.1 °C)		0613 4611
Efficient, robust NTC air probe		-50 to +125 °C Long-term meas. range +125 °C, short-term +150 °C	±0.2 °C (-25 to +80 °C) ±0.4 °C (remaining range)	60 s	0613 1712

☐ The specified seal class of the data loggers is achieved with these probes.

\* Probe tested to EN 12830 for suitability in the transport and storage sectors

## Accessories for testo 175 and 177

### testo 575 fast printer

- Fast-action print mechanism, 6 lines/s
- Prints tables/graphics
- Brief info. or full memory can be printed as required
- Determine section to be printed
- Your language can be set
- Self-adhesive Testo paper can also be used



Fast printout and logger rebooting with testo 575

Part no. 0554 1775



Alarm signal output for reliable notification of limits exceeded



Read out the data stored in the logger via the PC network using the Ethernet adapter

### testo 580 data collector

- Can read out up to 25 full testo 175 loggers or 10 full testo 177 loggers
- Displays all status information
- Download collected data to PC using Testo ComSoft 3



The testo 580 data collects data on site for upload to PC and analysis

RS232 Version

Part no. 0554 1778

USB version

Part no. 0554 1764

### testo 581 alarm signal output

- Transmission of alarm messages – e.g. when programmed limit values in the data logger are exceeded – to external components such as horns, lamps, PLC etc.
- Signal transfer via floating signal output

Part no. 0554 1769

### Ethernet adapter

- Fast transfer of readings
- Use of an existing network without additional cabling
- Long transmission paths
- Identification of measuring instruments in system network
- In connection with ComSoft 3

Part no. 0554 1711

Printer and Accessories	Part no.
Fast testo 575 printer, incl. 1 roll of thermal paper and batteries, infrared thermal line printer with graphics function	0554 1775
Spare thermal paper for printer (6 rolls)	0554 0569
Spare thermal paper for printer (6 rolls), measurement data documentation legible for up to 10 years	0554 0568
Label thermal paper (Testo patent) for testo 575 printer (6 rolls), can be applied directly	0554 0561
Additional accessories	Part no.
testo 580 data collector set with RS232, readout holders included, for testo 175/177 data loggers	0554 1778
testo 580 data collector set with USB, readout holders included, for testo 175/177 data loggers	0554 1764
testo 581 alarm signal output, floating, for testo 175/177, forwards information efficiently when limits are exceeded to e.g. horns, lamps, PLC etc.	0554 1769
Battery, 3.6 V/1.9 Ah 1AA, for testo 175-T1/175-T2 and all testo 177 loggers	0515 0177
Battery, 3.6 V/1.9 Ah 1AA, for testo 175-T1/175-T2 and all testo 177 loggers	0515 0177
Transport and Protection	Part no.
Lock for wall holder for testo 175/177 data loggers	0554 1755
Transport case for up to 6 testo 177 data loggers, testo 575 printer, testo 580 data collector and accessories	0516 1770
Accessories for humidity probes	Part no.
testo saline pots for control and humidity adjustment of humidity probes, 11.3 %RH and 75.3 %RH with adapter for humidity probe	0554 0660
Metal protection cage, Ø 12 mm for humidity probes, for measurement in flow velocities of less than 10 m/s	0554 0755
Cap with wire mesh filter, Ø 12 mm	0554 0757
Sintered PTFE filter, Ø 12 mm, for corrosive media, High humidity range (long-term measurements), high flow velocities.	0554 0756
Stainless steel sintered cap, Ø 12 mm, is screwed onto humidity probe, for measurements at higher flow velocities or in contaminated air	0554 0647

Software	Part no.
<b>For testo 175: ComSoft 4 Set - Basic with RS 232 interface.</b> Basic software with diagram and table function, incl. desk-top holder, PC connection cable	0554 1759
<b>For testo 175: ComSoft 4 Set - Basic with USB interface.</b> Basic software with diagram and table function, incl. desk-top holders, PC connection cable	0554 1766
<b>For testo 177: ComSoft 4 Set - Basic with RS 232 interface.</b> Basic software with diagram and table function, incl. desk-top holder, PC connection cable	0554 1774
<b>For testo 177: ComSoft 4 Set - Basic with USB interface.</b> Basic software with diagram and table function, incl. desk-top holders, PC connection cable	0554 1767
ComSoft 3 - Professional with data management, incl. data-base, analysis and graphics function, data analysis, trend curve (without interface)	0554 0830
ComSoft 3 - For requirements to CFR 21 Part 11, incl. data-base, analysis and graphics function, data analysis, trend curve (w/o interface)	0554 0821
RS232 interface for testo 175/177 incl. desk-top holders, PC connection cable, (please also order for ComSoft 3 - Professional)	0554 1757
USB interface, for testo 175/177 incl. desk-top holders, PC conn. cable, (Please order with ComSoft 3 - Professional)	0554 1768
Ethernet adapter, RS232 - Ethernet incl. software driver, mains unit, facilitates data communication in network	0554 1711
testo alarm modem GSM	Part no.
Magnetic foot aerial (dualband) with 3 m cable	0554 0524
Mains unit (top-hat rail mounting) 90 to 264 VAC/24 VDC (2.5 A)	0554 1749
Mains unit	0554 1142
Serial interface cable (RS232) for initial parameterization of the alarm modem	0449 0051
Calibration Certificates	Part no.
ISO calibration certificate humidity, calibration points 11.3 %RH and 75.3 %RH at +25 °C/+77 °F; per channel/instrument	0520 0076
DKD calibration cert./humidity, humidity data logger; cal. points 11.3%RH and 75.3%RH at +25°C; per channel/instrument	0520 0246
ISO calibration certificate/temperature, Surface in refrigerator, measurement points -18 °C; 0 °C; +60 °C	0520 0151
DKD calibration certificate/temperature, Temperature probe; cal. points -20°C; 0°C; +60°C (-4 °F, 92 °F, 140 °F); per channel/instrument	0520 0261

## The long termers with external probes

### testostor 171-1

You can place the testostor 171-1 data logger beside the goods, for example, and attach the external probe to doors or refrigeration appliances located up to 12m away. Air moisture can also be monitored, if required.

- Logs up to 55000 readings
- Probe can be positioned quickly and easily
- Tamperproof measurement results
- On site application: Testo Software for Palm OS® replaces laptop/PC

### testostor 171-4

testostor 171-4 with up to 4 external temperature probe sockets is used for simultaneous temperature measurement at different locations.



testostor 171-1, external probe socket can be positioned at up to 12m away

Data analysis on your PC/Notebook with easy-to-use Windows® Software

Monitor several refrigerated storerooms using testostor 171-4

#### testostor 171-1

**Int.: °C + Ext.: °C or %RH/°C**

Temperature data logger with °C/%RH probe socket, incl. magnetic start function, battery, calibration protocol (please order calibration certificates (DKD,350) separately)

**Part no. 0577 1715**

#### testostor 171-4

**4 x external °C**

Temperature data logger, 4 channels, with magnetic start function, battery and calibration protocol (please order calibration certificates (DKD,350) separately)

**Part no. 0577 1714**

Description	Illustration	Meas. range	Accuracy	Reaction time	Part no.
Robust immersion/air probe, quick-action, 6m cable, IP68 probe tip	40 mm Ø 3 mm	-50 to +80 °C	±0.2 °C (-25 to +80 °C) ±0.4 °C (-50 to -25.1 °C)	5 s t <sub>99</sub> (in water)	0610 1720
Air probe, highly accurate, can be attached directly	30 mm Ø 3 mm	-35 to +70 °C	±0.2 °C (-35 to +70 °C)	180 s ,90	0610 1722
Robust, accurate, waterproof food probe (IP65), made of stainless steel	125 mm Ø 4 mm Ø 3 mm	-50 to +120 °C	±0.2 °C (-25 to +80 °C) ±0.4 °C (-50 to -25.1 °C) ±0.5 °C (+80.1 to +120 °C)	10 s t <sub>99</sub> (in water)	0610 2217
Humidity/temperature probe with standard plastic protection cap	180 mm Ø 12 mm	0 to +100 %RH -20 to +70 °C	±2 %RH (+2 to +98 %RH) ±0.4 °C (-10 to +50 °C) ±0.5 °C (remaining range)	12 s ,90	0636 9717*

\*Humidity/Temperature probes only for testostor 171-1

testostor 171-1	Chann. intern, NTC	Chann. external (var.), NTC
Meas. range	-35 to +70 °C	0 to +100 %RH
Accuracy ±1 digit	±0.2 °C (-35 to +39.9 °C) ±0.4 °C (+40 to +70 °C)	±2 %RH (+2 to +98 %RH)
Resolution	0.1 °C	0.1 %RH
Common Technical Data		
Chann. external (var.), NTC		
Meas. range	-50 to +120 °C	
Accuracy ±1 digit	±0.2 °C (-34.9 to +39.9 °C) ±0.4 °C (+40 to +120 °C)	±0.6 °C (-50 to -35 °C)
Resolution	0.1 °C	
Oper. temp.	-35 to +70 °C	Memory 55000
Storage temp.	-40 to +85 °C	Dimensions 131 x 68 x 26 mm
Battery type	Lithium battery	Weight 305 g
Meas. rate: 2 s to 24 h, selectable		
Battery life: up to 5 years with lithium battery		
Software: menu-driven from Microsoft Windows 95 / ME / 2000 / XP / Vista		

Accessories Ordering data	Part no.
ComSoft 3 - Professional with data management, incl. database, analysis and graphics function, data analysis, trend curve	0554 0830
ComSoft 3 - For requirements to CFR 21 Part 11, incl. database, analysis and graphics function, data analysis, trend curve (w/o interface)	0554 0821
Interface, attachable to data logger	0554 1781
Transport case (plastic) for measurement data storage instruments (max. 6 off) and accessories	0516 0117
ISO calibration certificate/temperature, Surface in refrigerator, measurement points -18 °C; 0 °C; +60 °C	0520 0151



## Professional analysis of refrigeration systems

### Experts are our favourite customers



Detlef Higgleke,  
Head of Testo  
Academy

... because they know what they are doing. We offer you our support with our field-oriented trainings on measurement procedures and physical interrelations.

Even more important is the exchange with other specialists from your field. After all, we are dealing with your competence and your professional routine when using our instrument.

By the way: 98% of our training participants fully recommend our seminars and training.



Connection option for up to 4 ambient air probes per logger



Comprehensive range of probes for temperature, humidity, pressure, velocity, CO<sub>2</sub>, rpm, current and voltage



Analysis, documentation and filing of measurement data on PC



Large system case (aluminium) for control unit, up to 6 loggers, probes and accessories



## testo 454, simultaneous measurement at different sites

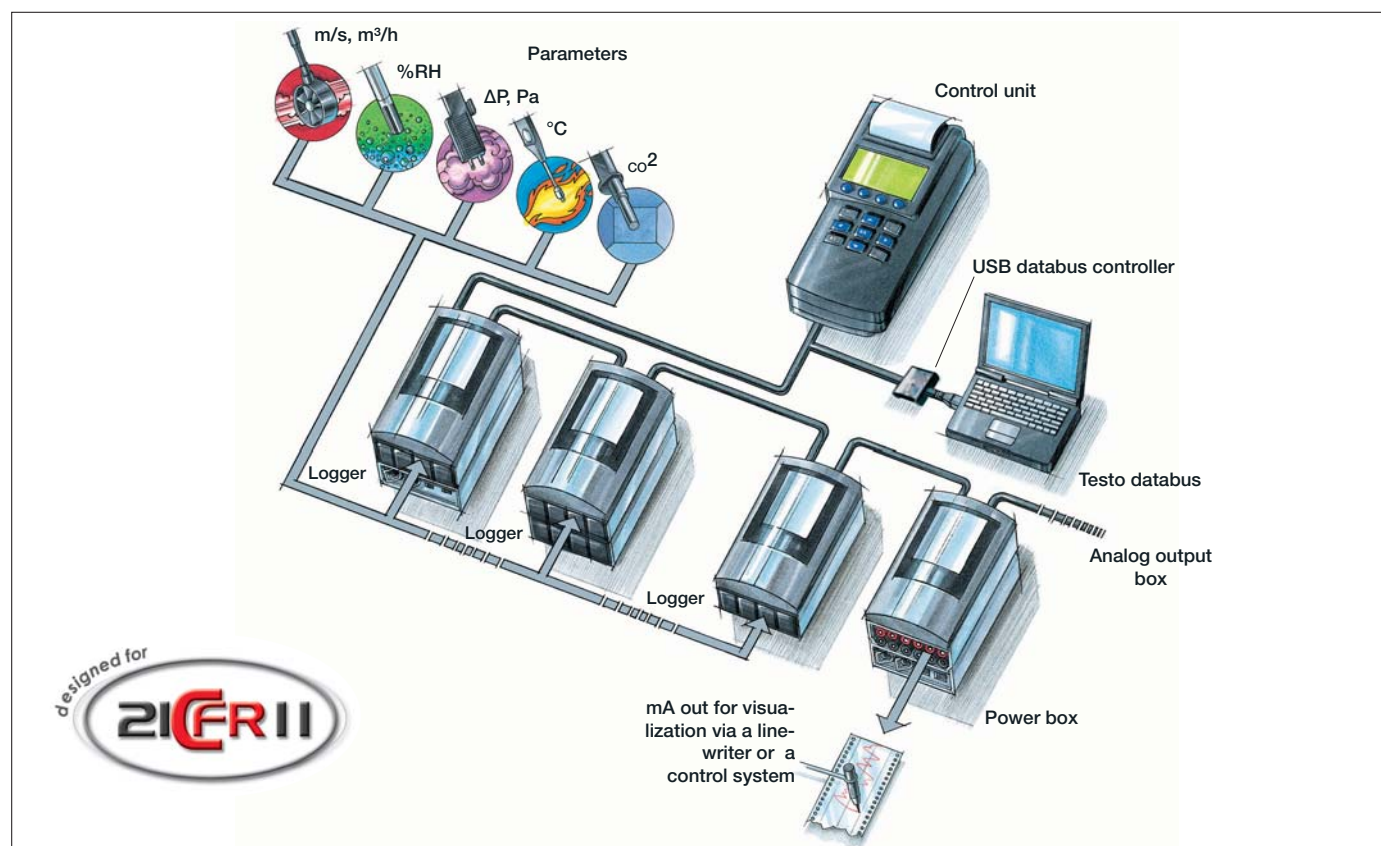

### Concept

The **testo 454** is the measuring system for flexible recording of multiple measurement data.

Particular advantages:

- Simultaneous measurement at several measuring locations
- Freely assignable probe inputs
- 1 to over 200 measurement channels
- Data transmission with the Testo databus
- Modular design of system components

### Parameters

A wide range of probes is available for accurate measurement in the respective applications:

- Temperature with surface, immersion, penetration, air or precision probes
- Humidity with room climate, duct and precision probes, material moisture probes and pressure dewpoint probes
- Velocity and volume flow with vanes, hot wire, hot bulb probes and Pitot tubes
- Indoor Air Quality using CO<sub>2</sub> probe or comfort level probe
- Pressure with differential/absolute/low pressure or high pressure probes
- rpm
- Current, voltage

### Logger

The data logger measures and saves readings without any connection to the control unit. Up to 4 more probes of your choice can be connected to this logger. Additional probe connection options are made possible by connecting more loggers. The following features give you flexibility when measuring data:

- Variable program start
- Adjustable measuring cycle
- Number of readings
- Program cancel can be defined

The measurement program can be started as follows:

- At a certain time or date
- Manually using function buttons
- If certain values are exceeded or undershot
- Via an event trigger socket signal

The exceeded alarm values can be evaluated for display or control via a relay.

### Control unit

The control unit displays the measurement data and controls the **testo 454** measuring system. The following parameters are programmed in the control unit:

- Locations
- Measurement programs
- Limits
- Precision adjustment
- System configuration

Efficient operation of the measuring system is guaranteed by the probe-dependent menu guide, for example, or the clear display of readings with names. The control unit is connected via the serial interface in the laptop/PC.

Additionally the control unit has all options for mobile use of a hand-held instrument.

### Testo databus controller

Alternatively, the Testo databus controller for the laptop/PC can be used in place of the control unit for reading out and control of the decentralised loggers. The Testo databus controller is connected via the USB interface of the PC/laptop.

Online measurement allows the readings from multiple loggers to be displayed easily and clearly on one screen. System-relevant data and readings are stored in the laptop/PC and in the loggers.

### Testo databus

Communication between control unit/logger, Testo databus controller/logger and other boxes takes place via the Testo databus. Using the Testo databus, you have the option of operating loggers at different locations. Distances of up to several hundred metres pose no problem for the Testo databus. In combination with the Testo databus controller and the software ComSoft 3, the testo 454 data loggers can be validated for requirements according to 21 CFR Part 11.

### Analog output box

The logger readings are output as a current signal (4-20 mA signal) for display units or output on an analog recorder.

### Power box

The power box is used to supply power to the loggers, control unit, analog output box and the Testo databus thus increasing operating life in the field.



## Professional analysis of refrigeration systems

### testo 454

The testo 454 multi-function measuring instrument is ideal for use on large refrigeration systems. By combining several data loggers, many parameters in a refrigeration system can be measured simultaneously (e.g. in a cold water substitute: superheating/subcooling + water's input and output temperature + high pressure + low pressure).

#### Concept

testo 454 is the system for flexible measurement of different measurement data.

Main features:

- Simultaneous measurement at several measurement points
- User defined probe sockets
- 1 to more than 200 measurement channels
- Data transmission with the Testo data bus
- Modular layout of system components



Testo databus controller to read and control loggers via laptop/PC



Measure superheating/subcooling and the oil pressure in an industrial refrigeration system

#### Recommended Set: Professional Set for large-scale refrigeration systems

Databus controller with USB connection incl. software ComSoft 3, cable for Testo databus, USB cable and terminal plug	0554 0589
Logger, measures and saves (max. 250,000 readings), incl. 4 user defined probe sockets, alarm output/event trigger socket, stand/wall holder	0577 4540
Low pressure probe, refrigerant-proof stainless steel, up to 10 bar, screw-in thread 7/16" UNF	0638 1741
High pressure probe, refrigerant-proof stainless steel, up to 40 bar, screw-in thread 7/16" UNF	0638 1941
Connection cable, 2,5 m long, for pressure probes	0409 0202
Connection cable, 2,5 m long, for pressure probes	0409 0202
Velcro probe for pipes with diameter of max. 75 mm	0628 0019
Velcro probe for pipes with diameter of max. 75 mm	0628 0019
Power box, connected to control unit to increase field operating life and supply power to Testo data bus	0554 1045
Power supply for power box (110/230 V; 50/60 Hz, 12 V, 3 A)	0554 1143
Connection cable, 5 m, for Testo data bus	0449 0043

Low/High pressure probes	Illustration	Overload	Meas. range	Accuracy	Conn.	Part no.
Low pressure probe, refrigerant-proof stainless steel, up to 10 bar, screw-in thread 7/16" UNF		25 bar	-1 to +10 bar	±1% of fsv	Plug-in head, connection cable 0409 0202 required	0638 1741
High pressure probe, refrigerant-proof stainless steel, up to 40 bar, screw-in thread 7/16" UNF		120 bar	-1 to +40 bar	±1% of fsv	Plug-in head, connection cable 0409 0202 required	0638 1941
Temperature probes	Illustration		Meas. range	Accuracy		Part no.
Velcro probe for pipes with diameter of max. 75 mm, Probe type Pt100			-50 to +150 °C	Class B		0628 0019

More probes available. Send for the brochure: "Multi-Function Measuring Instruments"



## Pressure meters for all measurement ranges

### testo 521

Highly accurate with internal differential pressure sensor, ideal for inspecting extraction units and ventilators and for monitoring pressure drops in filters.

The instrument also has two probe sockets to connect external temperature probes or pressure probes, for example, for simultaneous monitoring of condensation and evaporation pressure.

- Temp. compensated differential pressure sensor 0 to 100 hPa integrated in instrument
- 2 probe sockets for pressure and temperature
- Long-term analysis with internal data memory
- Printout on-site



Save data according to site and analyse on PC/notebook

Monitors filters using the external 100 Pa probe

#### testo 521-1

##### Accuracy 0.2% of fsv

Differential pressure meter 0 to 100 hPa incl. battery and calibration protocol

Part no. 0560 5210

#### testo 521-2

##### Accuracy 0.1% of fsv

Differential pressure meter 0 to 100 hPa incl. battery and calibration protocol

Part no. 0560 5211

Accessories Ordering data	Part no.
Connection hose, silicone, 5m long, max. load 700 hPa (mbar)	0554 0440
Connection hose set, 2 x 1 m, coiled, incl. 1/8" screw connection, pressure-tight up to 20 bar, for probe 0638 1647	0554 0441
Cable, 1.5 m long, connects probe with plug-in head to meas. instrument, PUR coating material	0430 0143
Connection cable, 2.5 m long, for pressure probes 0638 1741/1841/1941	0409 0202
TopSafe (protection case), incl. carrier strap, bench stand and magnet. Protects instrument from dust, impact, scratches	0516 0446
Testo fast printer with wireless infrared interface, 1 roll thermal paper and 4 AA batteries	0554 0549
ComSoft 3 - Professional with data management, incl. database, analysis and graphics function, data analysis, trend curve	0554 0830
RS232 cable, connects instrument to PC (1.8 m) for data transfer	0409 0178
Transport case, for measuring instrument, probes, Prandtl Pitot tube, accessories	0516 0527

Technical data		
Probe type	Piezoresistive pressure sensor (internal)	Pressure sensor for external pressure probes
Meas. range	0 ... 100 hPa	0 to 2000 hPa (piezoresistive) 0 to 40 bar (ceramic)
Accuracy ±1 digit	±0.2 % of fsv(testo 521-1) ±0.1 % of fsv(testo 521-2)	±0.1 % of mv (piezoresistive) ±0.2 % of fsv (ceramic)
Resolution	0.01 hPa	0.1 Pa (0638 1347) 0.001 hPa (0638 1447) 0.1 hPa (0638 1647) 0.01 bar (ceramic)
Overload	300 hPa	
Static pressure	2000 hPa	
Oper. temp. (compensated)	0 to +50 °C	Dimensions 219 x 68 x 50 mm
Storage temp.	-20 to +70 °C	Weight 300 g
Memory	25,000	Display LCD, 2 lines
PC	RS232 interface	Battery type 9 V (6LR61)

Differential pressure probes	Illustration	Meas. range	Accuracy	Conn.	Part no.	
Precision pressure probe, 100 Pa, in robust metal housing with impact protection, incl. magnet for fast attachment, to measure differential pressure and flow speeds (in combination with Pitot tube)		0 to +100 Pa	±(0.3 Pa ±0.5% of mv)	Plug-in head, connection cable 0430 0143 or 0430 0145 required	0638 1347	
Pressure probe, 10 hPa, in robust metal housing with impact protection incl. magnet for fast attachment, to measure differential pressure and flow speeds (in combination with Pitot tube)		0 to +10 hPa	±0.03 hPa	Plug-in head, connection cable 0430 0143 or 0430 0145 required	0638 1447	
Pressure probe, 1000 hPa, measures differential pressure, in robust metal housing with impact protection, incl. quick-closing coupling (M8 x 0.5), magnet for fast attachment		0 to +1000 hPa	±1 hPa (0 to 200 hPa) ±0.5% of mv (200 to 1000 hPa)	Plug-in head, connection cable 0430 0143 or 0430 0145 required	0638 1647	
Temperature probes	Illustration	Meas. range	Accuracy	t99	Part no.	
Pipe wrap probe for pipes with diameter of up to 2", for flow/return temp. meas. in hydronic systems		-60 to +130 °C	Class 2	5 s	0600 4593	
Highly accurate air probe for air and gas temperature measurements with bare, mechanically protected sensor	 150 mm Ø 9 mm	-40 to +130 °C	To UNI curve	60 s	0610 9714	
Relative pressure probes	Illustration	Overload	Meas. range	Accuracy	Conn.	Part no.
Low pressure probe, refrigerant-proof stainless steel, up to 10 bar, screw-in thread 7/16" UNF		25 bar	-1 to +10 bar	±1% of fsv	Plug-in head, connection cable 0409 0202 required	0638 1741
High pressure probe, refrigerant-proof stainless steel, up to 30 bar, screw-in thread 7/16" UNF		120 bar	-1 to +30 bar	±1% of fsv	Plug-in head, connection cable 0409 0202 required	0638 1841
High pressure probe, refrigerant-proof stainless steel, up to 40 bar, screw-in thread 7/16" UNF		120 bar	-1 to +40 bar	±1% of fsv	Plug-in head, connection cable 0409 0202 required	0638 1941



# Testo: At Your Service



**205 Westwood Ave  
Long Branch, NJ 07740  
1-877-742-TEST (8378)  
Fax: (732) 222-7088  
salesteam@Tequipment.NET**

Please send for more information:

Monitoring Instruments for Food Production, Transport and Storage  
Measurement Engineering for Restaurants, Catering and Supermarkets

Measurement Engineering for Air Conditioning and Ventilation

Measurement Engineering for Heating and Installation

Measurement Solutions for Emissions, Service and Thermal Processes

Measurement Solutions for Refrigeration Technology

Stationary Measurement Solutions for Air Conditioning, Drying, Cleanrooms and Compressed Air

Measurement Solutions for Production, Quality Control and Maintenance

Measurement Solutions for Climate Applications in Industry

Reference Measurement Technology for Industry

Measuring Instruments For Temperature

Measuring Instruments for Humidity

Measuring Instruments For Velocity

Measuring Instruments for Pressure and Refrigeration

Multi-Function Measuring Instruments

Measuring Instruments for Flue Gas and Emissions

Measuring Instruments for RPM, Analysis, Current/Voltage

Measuring Instruments For Indoor Air Quality, Light And Sound

Stationary Measurement Technology Humidity / Differential Pressure / Temperature / Process Displays

Stationary Measurement Technology Compressed Air Humidity / Compressed Air Consumption



More service:

- First calibrations
- Recalibrations
- Advice, seminars, training
- Custom-designed solutions
- 10 year service guarantee
- Highly specialised service experts worldwide

More assurance:

- Highly qualified, individually trained staff
- More than 50 years' experience, more than one million measuring instruments in use
- DIN EN ISO 9001 certification
- Worldwide presence and accessibility

More user-friendliness:

- Uncomplicated and fast exchange of wear parts such as batteries, rechargeable batteries



## Contents

		Page
<b>Pressure / Refrigeration</b>		
testo 556-1/-2	The professional solution for service and maintenance	6
testo 560-1/-2	The professional solution for commissioning, service and maintenance	6
testo 523	The starter for service and maintenance	8
testo 316-4	Leakage detector for refrigerants	11
testo 521-1/-2	Pressure meters for all measurement ranges	51
<b>Flow</b>		
testo 435-1/2	Multi-purpose measuring instrument for analysing refrigeration systems	12
testo 416	Measures air velocity, with telescopic vane	16
testo 417	Measures volume flow and temperature, with 100 mm vane	16
testo 425	Measures air velocity, with thermal flow probe	17
testo 405-V1	Measure air flow, volume flow and temperature, with a thermal anemometer	17
<b>Humidity</b>		
testo 635-1/2	Thermohygrometer, professional and safe	18
testo 625	Monitors Indoor Air Quality, flexible and robust	22
testo 608-H1/-H2	Monitors ambient production air conditions – reliably and safely	23
testo 605-H1	Measures air humidity, flexibly and easily	23
testo 175-H1/-H2	Monitors refrigerated rooms, efficiently and reliably	44
testo 177-H1	Long-term refrigeration storage monitoring, professional and non-stop	45
testostor 171-1	The long-termer with external probe	47
<b>Temperature</b>		
testo 735-1/-2	Highly precise alarm and logger thermometer – with measurement location management	24
testo 925/922	Fast temperature measurement with wide measurement range	28
testo 110	Temperature measurement, highly accurate	31
testo 905-T2	Temperature measurement, accurate and super fast	33
Mini thermometer	Temperature measurement, fast and easy	33
testo 830-T1/-T2/-T3	Non-contact temperature measurement with laser sighting	34
testo 845	Infrared measurement technology for temperature with integrated humidity module	36
testo 177-T1/-T2	Pro data loggers for long-term monitoring	41
testo 177-T3	The data logger with 2 probe sockets and event logging	42
testo 177-T4	Professional long-term monitoring, data logger with 4 probe sockets	43
testostor 171-1/-4	The long-termers with external probes	47
<b>Sound</b>		
testo 815/816	Sound level measurement – to DIN/IEC 60651, Class 2	39
<b>Endoscopy</b>		
testo 319	Versatile fiberscope for fast diagnoses	38
<b>rpm</b>		
testo 465	rpm measurement, non-contact	39
testo 470	rpm measurement, non-contact and mechanical	39
<b>Multi-function</b>		
testo 454	Professional analysis of refrigeration systems	48
testo 400	THE reference for refrigeration and air conditioning systems	51
<b>Stationary measurement engineering</b>		
testo 6740	Pressure dewpoint transmitter – reliable trace humidity measurement	54