

# 8D - D38999 Composite Series



## MIL-DTL-38999 Serie III Composite Series

# 8D - D38999 Composite Series



## Connector part numbers

Basic Series	8D	0	-	11	J	35	P	N	**
<b>Shell style:</b> <b>0:</b> Square flange receptacle <b>1:</b> In line receptacle <b>5:</b> Plug with RFI shielding.									
<b>Type:</b> <b>-:</b> Connectors with standard crimp contacts. <b>L:</b> Receptacle with long spill (male and female size #22D, #20). <b>C:</b> Receptacle with short spill (male and female #22D, #20, #16). <b>S:</b> Receptacle with specific spill (male et female #22D) <b>W:</b> Receptacle with male contacts #22D for wire wrap (3 wraps) <b>T:</b> Receptacle with male contacts #20 for wire wrap (2 wraps)									
<b>Shell size:</b> 09 - 11 - 13 - 15 - 17 - 19 - 21 - 23 - 25									
<b>Plating:</b> <b>J:</b> Olive drab cadmium <b>M:</b> Nickel <b>X:</b> Without plating									
<b>Contact layout:</b> See page 8 to 11									
<b>Contact type:</b> <b>P, H:</b> Pin <b>A:</b> Connector supplied less pin contact or with specific contacts (Connector marking: A+ orientation) <b>S, J:</b> Socket <b>B:</b> Connector supplied less socket contact or with specific contacts (Connector marking: B+ orientation) <b>P &amp; S: 500 mating - unmating      J &amp; H: 1500 mating - unmating</b>									
<b>Orientation:</b> N, A, B, C, D & E (see page 58)									
<b>Spécification:</b> <b>046:</b> Tinned straight spills <b>251:</b> Connector provided with power contacts (layouts with contacts #8) <b>L:</b> For P or S contact only, connectors delivered without contacts, connectors marking P or S plus orientation.									

## MIL-DTL 38999 part numbers\*

Basic Series	D38999	20	M	B	35	P	N	L
<b>Shell style:</b> <b>20:</b> Square flange receptacle <b>26:</b> Plug with RFI shielding.								
<b>Plating:</b> <b>J:</b> Olive drab cadmium <b>M:</b> Nickel								
<b>Shell size:</b> A - B - C - D - E - F - G - H - J								
<b>Contact layout:</b> See page 11 for layout according to MIL-DTL-38999								
<b>Contact type:</b> <b>P, H:</b> Pin. <b>A:</b> Connector supplied less pin contact or with specific contacts (connector marking: A + orientation). <b>S, J:</b> Socket. <b>B:</b> Connector supplied less socket contact or with specific contacts (connector marking: B + orientation). <b>P &amp; S = 500 mating - unmating      J &amp; H = 1500 mating - unmating</b>								
<b>Orientation:</b> N, A, B, C, D & E (see page 58)								
<b>L:</b> For P or S contact type only, connector delivered without contacts, connector marking P or S (without L)								

\* **Note:** To place an order of MIL connectors delivered without MIL removable crimp contacts and keep P or S plus orientation marking, it must be specify clearly on the order (by adding a suffix L at the end of the P/N or specified in comment).

# 8D - D38999 Composite Series



## Dimensions

### Receptacle type 0

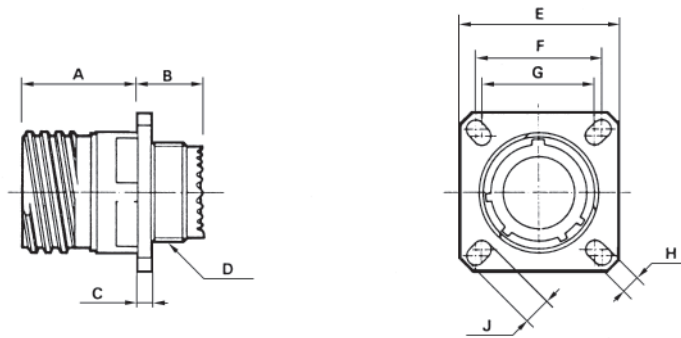

Shell size	A Max.	B Max.	C Max.	D thread	E ± 0,30	F	G	H ± 0,20	J ± 0,20
<b>09 (A)</b>	19.50	10.60	3.65	M12 x 1-6g	23.80	18.26	15.09	3.25	5.49
<b>11 (B)</b>	19.50	10.60	3.65	M15 x 1-6g	26.20	20.62	18.26	3.25	4.93
<b>13 (C)</b>	19.50	10.60	3.65	M18 x 1-6g	28.60	23.01	20.62	3.25	4.93
<b>15 (D)</b>	19.50	10.60	3.65	M22 x 1-6g	31.00	24.61	23.01	3.25	4.93
<b>17 (E)</b>	19.50	10.60	3.65	M25 x 1-6g	33.30	26.97	24.61	3.25	4.93
<b>19 (F)</b>	19.50	10.60	3.65	M28 x 1-6g	36.50	29.36	26.97	3.25	4.93
<b>21 (G)</b>	18.70	11.40	4.35	M31 x 1-6g	39.70	31.75	29.36	3.25	4.93
<b>23 (H)</b>	18.70	11.40	4.35	M34 x 1-6g	42.90	34.93	31.75	3.91	6.15
<b>25 (J)</b>	18.70	11.40	4.35	M37 x 1-6g	46.00	38.10	34.93	3.91	6.15

Dimensions in millimeters

### In line receptacle type 1

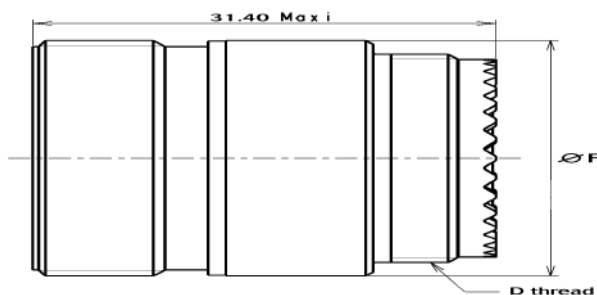

Shell size	D thread	Ø F
<b>09 (A)</b>	M12 x 1-6g	15.80
<b>11 (B)</b>	M15 x 1-6g	18.85
<b>13 (C)</b>	M18 x 1-6g	22.00
<b>15 (D)</b>	M22 x 1-6g	25.20
<b>17 (E)</b>	M25 x 1-6g	29.95
<b>19 (F)</b>	M28 x 1-6g	31.55
<b>21 (G)</b>	M31 x 1-6g	34.70
<b>23 (H)</b>	M34 x 1-6g	37.90
<b>25 (J)</b>	M37 x 1-6g	41.20

# 8D - D38999 Composite Series



## Plug type 5

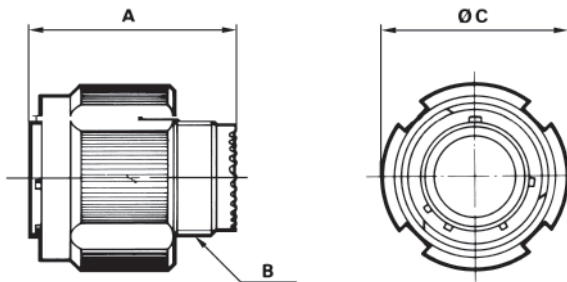

Shell size	A Max.	B thread	C Max.
09 (A)	31.00	M12 x 1-6g	21.80
11 (B)	31.00	M15 x 1-6g	25.00
13 (C)	31.00	M18 x 1-6g	29.40
15 (D)	31.00	M22 x 1-6g	32.50
17 (E)	31.00	M25 x 1-6g	35.70
19 (F)	31.00	M28 x 1-6g	38.50
21 (G)	31.00	M31 x 1-6g	41.70
23 (H)	31.00	M34 x 1-6g	44.90
25 (J)	31.00	M37 x 1-6g	48.00

## Mated connectors dimensions

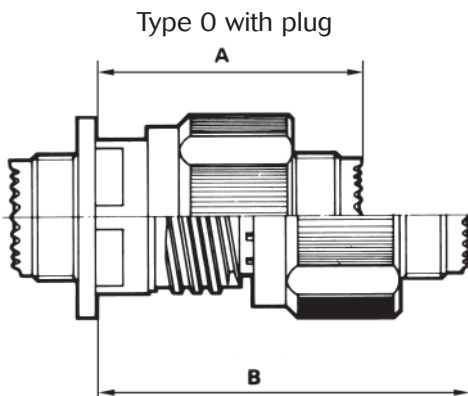

Shell size	A Max.	B Max.
09 (A)	37.00	52.30
11 (B)	37.00	52.30
13 (C)	37.00	52.30
15 (D)	37.00	52.30
17 (E)	37.00	52.30
19 (F)	37.00	52.30
21 (G)	36.00	51.30
23 (H)	36.00	51.30
25 (J)	36.00	51.30

Dimensions in millimeters

# 8D - D38999 Composite Series



## Receptacle with straight spill contacts

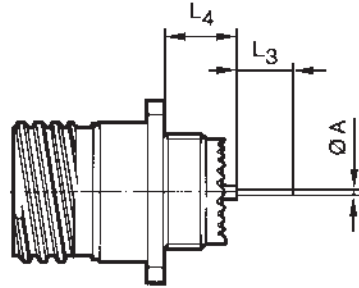

		Shell size			09	11	13	15	17	19	21	23	25
		Contact size	Contact type	Spill type	(A)	(B)	(C)	(D)	(E)	(F)	(G)	(H)	(J)
<b>A</b>		# 22D	M & F	L & C					0.70				
		# 22D	M & F	S					0.50				
		# 20	M & F	C					0.70				
		# 16	M & F	C					1.15				
<b>L3</b>		# 22D	M & F	L					8.50				
		# 22D	M & F	C					4.00				
		# 22D	M & F	S					5.00				
		# 20	M & F	C					5.00				
		# 16	M & F	C					5.00				
<b>L4</b>	<b>Min.</b>	# 22D	M	L & C					9.48				
	<b>Max.</b>	# 22D	M	L & C			10.38				10.48		
	<b>Min.</b>	# 22D	F	L & C			9.15				9.26		
	<b>Max.</b>	# 22D	F	L & C			10.58				10.69		
	<b>Min.</b>	# 22D	M	S			9.65				9.76		
	<b>Max.</b>	# 22D	M	S			10.55				10.65		
	<b>Min.</b>	# 22D	F	S			9.65				9.76		
	<b>Max.</b>	# 22D	F	S			10.55				10.65		
	<b>Min.</b>	# 20	M	C			9.65				9.76		
	<b>Max.</b>	# 20	M	C			10.55				10.65		
	<b>Min.</b>	# 20	F	C			9.65				9.76		
	<b>Max.</b>	# 20	F	C			10.55				10.65		
	<b>Min.</b>	# 16	M	C			9.65				9.76		
	<b>Max.</b>	# 16	M	C			10.55				10.65		
	<b>Min.</b>	# 16	F	C			9.65				9.76		
	<b>Max.</b>	# 16	F	C			10.55				10.65		

M : Male contact      F: Female contact      L: Long spill      C : Short spill      S: Specific spill

Dimensions in millimeters

# 8D - D38999 Composite Series



## Standard backshells part numbers

### Straight cable clamp (M85049/91)

**Basic series** M85049 91 11 M

**Backshell type:**

91: Straight cable clamp

**Shell size:**

09 - 11 - 13 - 15 - 17 - 19 - 21 - 23 - 25

**Plating:**

J: Cadmium olive drab over electroless nickel

M: Electroless nickel

T: Without plating

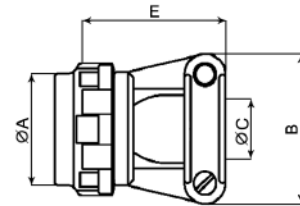

See table 1 for dimensions

### 90° cable clamp (M85049/92)

**Basic series** M85049 92 11 M

**Backshell type:**

92: 90° cable clamp

**Shell size:**

09 - 11 - 13 - 15 - 17 - 19 - 21 - 23 - 25

**Plating:**

J: Cadmium olive drab over electroless nickel

M: Electroless nickel

T: Without plating

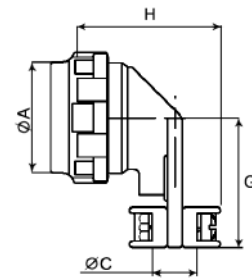

See table 1 for dimensions

**Table 1**

Shell size	ØA Max.	B Max.	ØC Max.	E Max.	G	H
09	21.80	24.90	5.55	21.25	22.20	26.95
11	25.00	26.0	6.70	24.30	23.80	27.95
13	29.40	30.50	8.75	27.95	26.20	30.00
15	32.50	33.00	11.70		28.60	33.00
17	35.70	36.10	13.85	31.25	33.30	35.05
19	38.50	38.60	15.60	35.80	34.95	36.85
21	41.50	41.65	17.75	38.35	38.10	39.15
23	44.90	45.00	19.80	42.15	41.30	41.15
25	48.00	48.00	21.60	44.70	44.45	42.95

# 8D - D38999 Composite Series



## Straight backshell for heat shrink boots accommodation (M85049/88)

**Basic series**      **M85049**    **88**    **11**    **M**    **02**

**Backshell type:**

**88:** Straight backshell for heat shrink boots

**Shell size:**

09 - 11 - 13 - 15 - 17 - 19 - 21 - 23 - 25

**Plating:**

**J:** Cadmium olive drab over electroless nickel

**M:** Electroless nickel

**Entry size:**

**02** ou **03:** see table 2

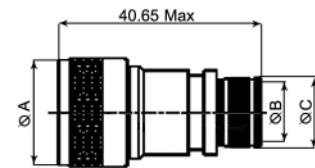

See tableau 2 for dimensions

**Table 2**

Shell size	ØA Max.	ØB +/- 0.10		Entry size	
		02	03	02	03
<b>09</b>	21.79	N/A	6.35	N/A	10.03
<b>11</b>	24.99	N/A	7.92	N/A	11.61
<b>13</b>	29.39	7.92	11.13	11.61	14.81
<b>15</b>	32.49	11.13	14.27	14.81	17.96
<b>17</b>	35.71	12.70	15.88	16.38	19.56
<b>19</b>	38.51	15.88	19.05	19.56	22.73
<b>21</b>	41.71	15.88	20.62	19.56	24.30
<b>23</b>	44.91	17.47	23.83	21.06	27.51
<b>25</b>	47.98	19.05	25.40	22.73	29.08

Dimensions in millimeters

# 8D - D38999 Composite Series



## Connectors weight

	With contacts				Without contact			
	Plug (type 5)		Receptacle (type 0)		Plug (type 5)		Receptacle (type 0)	
	Male	Female	Male	Female	Male	Female	Male	Female
09-35	8.5	10.1	7.8	9.4	8.1	8.6	7.4	7.9
09-98	8.5	9.8	7.8	9.1	8.1	8.6	7.4	7.9
11-01	12.8	15.7	10.4	13.3	12.1	14.1	9.7	11.7
11-02	11.5	14.1	09.3	11.8	10.9	12.5	08.7	10.3
11-04	12.6	15.7	10.2	13.3	12.0	14.1	9.7	11.7
11-05	12.6	15.8	10.2	13.4	11.9	13.8	9.5	11.5
11-22	11.4	13.8	09.1	11.6	11.1	12.8	08.8	10.6
11-35	12.5	16.0	10.1	13.6	11.6	12.8	9.2	10.4
11-80	15.25	18.6	13.40	10.4	10.75	11.63	08.90	09.4
11-98	12.5	15.3	10.1	12.9	11.7	12.8	9.3	10.5
11-99	11.8	15.0	09.6	12.8	10.8	12.2	08.6	10.0
13-04	17.2	20.9	13.7	17.5	15.6	17.9	12.4	14.3
13-08	17.6	22.8	14.1	19.2	16.5	19.6	12.9	16.1
13-26	17.9	23.6	14.4	20.1	16.2	18.9	12.7	15.4
13-35	17.4	23.1	13.8	19.6	15.8	17.6	12.3	14.1
13-98	17.2	21.8	13.7	18.3	15.8	17.9	12.3	14.3
15-05	21.4	26.7	16.6	21.9	19.8	22.8	15.0	18.0
15-15	22.2	29.3	17.4	24.5	19.9	23.0	15.1	18.1
15-18	22.4	31.3	17.6	26.5	19.9	24.0	15.0	19.2
15-19	22.0	29.6	17.1	24.8	19.2	22.0	14.5	17.2
15-35	22.0	31.3	17.2	26.5	19.4	22.0	14.6	17.2
15-97	21.8	28.9	17.1	24.1	19.4	22.6	14.7	17.8
17-02	26.51	38.85	25.23	37.57	19.35	22.35	18.07	21.07
17-06	25.9	35.5	23.2	32.8	21.9	25.9	19.2	23.2
17-08	24.9	33.6	22.2	30.1	22.4	27.4	19.7	24.7
17-26	25.5	36.3	22.8	33.6	21.8	25.9	19.2	23.1
17-35	25.7	39.3	23.0	36.6	21.9	25.5	19.2	22.8
17-75	31.3	42.6	28.6	39.9	22.3	28.6	19.6	25.9
17-99	25.5	36.1	22.8	33.4	22.0	26.1	19.3	23.4
19-11	32.1	45.7	26.1	39.7	28.7	37.1	22.7	31.1
19-32	31.3	44.7	25.3	38.7	26.8	31.9	20.8	25.9
19-35	31.6	48.1	25.6	42.0	27.1	31.6	21.0	25.6
21-11	38.0	57.9	32.8	52.6	30.8	40.3	25.5	35.1
21-16	35.1	50.4	29.9	45.2	30.2	37.9	24.9	32.7
21-35	35.4	56.1	30.1	50.8	29.9	36.3	24.6	31.1
21-39	36.8	57.1	31.5	51.9	31.0	40.8	25.7	35.5
21-41	35.3	52.7	30.1	47.5	29.6	36.3	24.3	31.0
21-48	42.41	62.40	37.71	57.70	29.3	36.2	24.6	31.5
21-75	47.3	64.2	42.6	59.50	29.3	36.2	24.6	31.5
23-21	43.1	66.3	38.0	61.2	36.5	49.9	31.5	44.8
23-35	41.4	67.5	36.3	62.5	34.4	42.5	29.3	37.5
23-53	41.5	63.6	36.4	58.6	34.1	42.4	29.0	37.4
23-55	42.2	65.3	42.2	60.2	34.5	43.3	29.4	38.2
25-07	53.6	90.05	49.0	84.85	37.8	51.8	33.2	46.6
25-11	59.08	81.60	54.48	77.00	40.8	53.8	36.2	49.2
25-19	51.7	83.7	46.6	78.6	39.2	53.3	34.0	48.2
25-24	51.2	82.5	46.1	77.4	39.6	54.0	34.4	48.9
25-29	49.5	78.5	44.4	73.4	40.5	55.9	35.4	50.7
25-35	47.3	80.1	42.2	75.0	38.4	48.1	33.2	43.0
25-37	49.27	80.36	45.47	76.16	37.8	51.50	34.0	47.30
25-44	69.64	93.70	65.04	94.65	36.1	45.80	31.5	46.75
25-43	49.6	80.2	44.4	75.1	40.1	55.4	35.0	50.3
25-46	51.9	75.7	46.7	70.1	37.2	47.4	32.1	42.2
25-61	46.6	73.4	41.5	68.2	38.1	48.9	32.9	43.8
25-08	72.9	104.8	67.8	99.6	36.9	48.8	31.8	43.6
25-20	57.9	88.2	52.8	83.0	36.4	46.6	31.3	41.5
25-04	50.4	80.2	45.3	75.0	41.2	54.8	36.1	49.6