

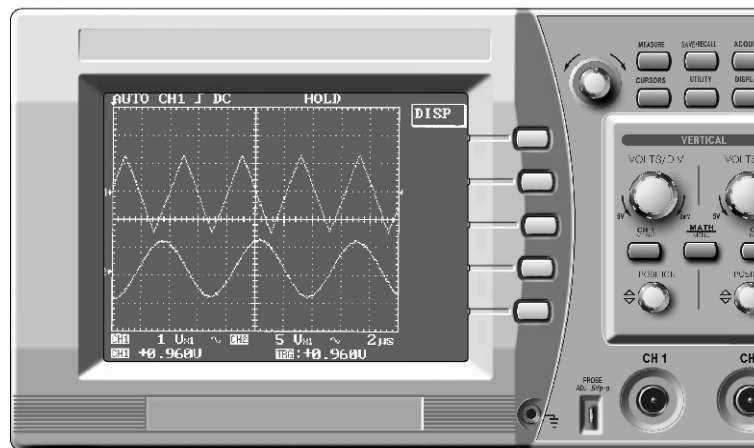

Digital Oscilloscope

DS-1000 Series

Digital Oscilloscope Operation Manual





Digital Oscilloscope

DS-1000 Series

Digital Oscilloscope Operation Manual

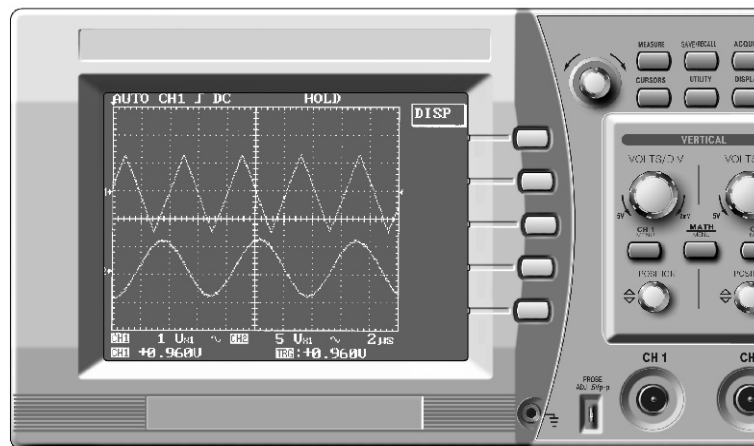

DECLARATION OF CONFORMITY

Manufacture's name : EZ Digital Co., Ltd

Manufacture's Address : 222-28, Nae-dong, Ojeong-gu,
Bucheon-si, Gyeonggi-do
R.O.KOREA, 421-160

Declares that the product :

Product name : Oscilloscope
Model number : DS - 1XXX (X : 0 ~ 9)
Date : December, 01, 2001

Conforms to the following product specifications:

Safety : EN 61010-1 : 1993 + A2 : 1995
(IEC 10101 : 1990 + A1 : 1992
+ A2 : 1995, Modified)

EMC : EN 61326/1997 + A1:1998

Supplementary information:

The product herewith complies with the requirements of the
Low Voltage Directive 73/23/EEC and the EMC Directive 89/336/EEC

Bucheon, Gyeonggi

Location

C. Y. Kim

Cheol Young Kim
Quality Assurance Manager

WARRANTY

This instrument is warranted against defects in workmanship and materials. If any failure, resulting from a defect in either workmanship or material should occur under normal use within a year from the original date of purchase, such failure will be corrected free of charge to the purchaser by repair or replacement of the defective part or parts. When the failure is a result of user's neglect, natural disaster or accident, we charge for repairs regardless of the warranty period.

This warranty is subject to the following conditions and limitations.

The warranty is void and inapplicable if the defective product is not brought or sent prepaid to our authorized service center or sales outlet within a warranty period. Defective product is, on EZ Digital Co., Ltd.'s sole judgement, indemnified at a purchased price, replaced with new one or repaired without charge or with charge.

In the event warranty service is needed, purchaser should get in touch with the service center or sales outlet, or properly pack and return the product to the service center or sales outlet at his or her own expense. A returned product must be accompanied by a written description of the defect. We return the product to the purchaser at his or her own expense.

In case the warranty does not cover the product on EZ Digital Co., Ltd.'s sole judgement, we repair the product after obtaining prior permission from the purchaser who received pro forma statement about repairing charges. In such a case, EZ Digital Co., Ltd. bears the transportation expenses required to send back all the repaired products temporarily, and then repair and transportation expenses will be charged against the purchaser by the statement of accounts.

When the authorized sales agents sell our product, they must notify the purchaser of the warranty contents, but have no right to stretch the meaning of original warranty contents or offer additional warranty. EZ Digital Co., Ltd. does not provide any other promise or suggestive warranty and holds no liability for the damage caused by negligence, abnormal use or natural disaster. EZ Digital Co., Ltd. is not responsible for damages though it was notified about the danger in advance.

For more information on service or overall repairs and maintenance of old and decrepit products, be sure to contact our service center or sales outlet.

PRODUCT CONTENTS

OSCILLOSCOPE

- Set 1 set



SUPPLIED ACCESSORIES

- Operation manual
- Power cord
- 100MHz probes x1/x10 2EA (Only DS-1100)

OPTIONAL ACCESSORIES

- RS-232C thermal printer (Printy2™ with RS-232C Cable)
- Test probes
 - 150MHz probes x1/x10
 - 250MHz probes x1/x10
- Service manual
- PC Software kit(RS-232C Cable, USB Cable, PC interface Program)
- Interface Card Type A (RS-232C, Centronics, USB)
- Interface Card Type B (RS-232C, Centronics)

CONTENTS

1. INTRODUCTION	7
1-1 KEY FEATURES	8
1-2 NOTES FOR A SAFETY OPERATION	9
1-2-1 OPERATING ENVIRONMENT	9
1-2-2 SAFETY SYMBOLS	9
 1-2-3 POWER SOURCE-RELATED WARNINGS	10
1-2-4 PLACE-RELATED WARNINGS	10
1-2-5 OPERATION-RELATED WARNINGS	11
1-2-6 SERVICE-RELATED WARNINGS	12
1-2-7 CLEANING AND MAINTENANCE	13
1-3 NOTES TO USERS	14
1-3-1 NOTICE FOR PROPER MEASUREMENT	14
 1-3-2 WHEN CONNECTING PERIPHERAL DEVICES	15
1-3-3 PROBE	18
1-4 INSTALLATION	20
1-4-1 POWER CODE	20
1-4-2 INTERFACE CARD	20
2. DESCRIPTION	22
2-1 KEY & DISPLAY DESCRIPTION	23
2-1-1 DISPLAY OVERVIEW	23
2-1-2 VERTICAL AXIS OPERATION	25
2-1-3 HORIZONTAL AXIS OPERATION	26
2-1-4 TRIGGER	27
2-1-5 MENUS	28
2-1-6 CONNECTORS	29
2-1-7 THE MENU BOX BUTTON AND FUNCTION KNOB	29
2-2 MENUS	30
2-2-1 AUTOSET	30
2-2-2 VERTICAL	31
2-2-3 MATH	33
2-2-4 HORIZONTAL	37
2-2-5 TRIGGER	38

2-2-6 MEASURE	43
2-2-7 SAVE/RECALL	45
2-2-8 ACQUIRE	47
2-2-9 CURSORS	49
2-2-10 UTILITY	51
2-2-11 DISPLAY	53
2-2-12 HARDCOPY	55
2-3 USING THE FUNCTIONS EFFECTIVELY	56
2-3-1 USING THE ZOOM FUNCTION	56
2-3-2 USING THE SINGLE FUNCTION	57
2-3-3 USING FFT (FAST FOURIER TRANSFORMATION)	58
3. APPENDIX	60
3-1 SPECIFICATIONS	61
3-2 FACTORY DEFAULTS	65

1. INTRODUCTION

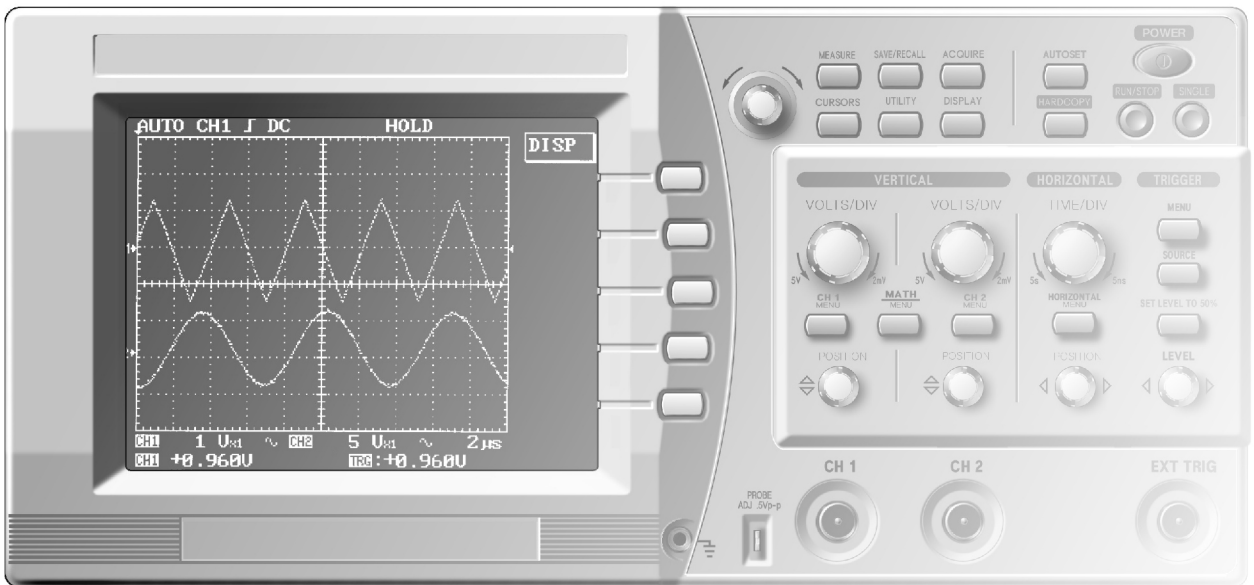

1-1 KEY FEATURES

The 16bit high speed microprocessor adoption enables the scope to acquire a typical 100,000 points per second and quickly update the picture on the screen.

Basic memory length of DS-1150 is 10kB and that of DS-1150 & DS-1250 is 32kB. Captured waveforms can be zoomed in and analyzed in detail. Also its built-in 10ns peak detection circuit enables it to capture high frequency noise even at a low speed time/div and magnify and analyze it using the zoom-in function. In addition, it can save up to 10 waveforms and provide diversified analysis function like FFT which is available on high priced products.

General Features

- 100MHz bandwidth(DS-1100), 2 CH dual digitizer
- 150MHz bandwidth(DS-1150), 2 CH dual digitizer
- 250MHz bandwidth(DS-1250), 2 CH dual digitizer
- 100MS/s simultaneous maximum sampling rate per channel, 200MS/s sampling rate for one channel only
- 25GS/s equivalent sampling rate per channel
- 10ns peak detection for glitch capture even in ROLL mode
- Max. 400Vpk input voltage into all channels

Convenient Functions

- Direct single trigger capture function using a hot-key
- Simultaneous 5 waveform informations auto measurement and FFT analysis
- Auto trigger level setting to 50%
- Saving 10 waveforms & 10 setup parameters
- Convenient inserting interface card for RS-232C, hardcopy and USB

1-2 NOTES FOR A SAFETY OPERATION

1-2-1 OPERATING ENVIRONMENT

This instrument will operate to its specifications if the environment is maintained within the following conditions.

- Indoor use
- Altitude up to 2000m use
- Operating temperature 0°C ~ 40°C
- Relative humidity $\leq 80\%$
- Main supply voltage fluctuations not exceed $\pm 10\%$ of the nominal voltage.
- After turning on the instrument, please allow a pre-heating period of as long as some 15 minutes.

This instrument has been qualified to the following EN61010-1 Category :

- Installation (Over-voltage) category 2
- Pollution Degree 2

1-2-2 SAFETY SYMBOLS

Where these symbols or indications appear on the instrument or in this manual, they have the following meanings.



Refer to accompanying documents for Safety-related information.

Wherever the symbol is present, see "NOTES FOR A SAFETY OPERATION" part in this manual.



Ground

WARNING

Risk of hazard which may cause injury to human body or danger to life. If a WARNING appears on the instrument , and in this manual, do not proceed until its suitable conditions are understood and met.

CAUTION

Risk of hazard which causes fire or serious damage to the instrument or other equipment. Do not proceed until its suitable conditions are met.

1-2-3 POWER SOURCE-RELATED WARNINGS

Protection of Power Cord and Unplugging



Power-supply cords should be routed so that they are not likely to be waked on or pinched by items placed upon or against them, paying particular attention to cords at plugs, convenience receptacles, and the point where they exit from the instrument. For added protection for this instrument during a lightening storm, when it is left unattended and unused for long periods of time, unplug it from the power source. This will prevent damage to the instrument due to lightening and power-line surges.

Overloading

Do not OVERLOAD power source and extension cords as this can result in a risk of fire or electric shock.

1-2-4 PLACE-RELATED WARNINGS

Object and Liquid Entry

Never push objects of any kind into this instrument through openings as they may touch dangerous voltage points or short out parts that could result in a fire or electric shock. Never spill liquid of any kind on the instrument. Do not use this instrument near water- for example, near a bath tub wash bowl, kitchen sink, or laundry tub, in a wet basement, or near a swimming pool, and the like. Keep the instrument away from damp air, water and dust.

Unexpected trouble may be caused when the instrument is placed in a damp or dusty place.



FLAMMABLE AND EXPLOSIVE SUBSTANCE

Avoid using this instrument where there are gases, and where there are flammable and explosive substances in the immediate vicinity.

Unstable Location

Do not place this instrument on an unstable cart, stand, tripod, bracket, or table. The instrument may fall, causing serious injury to a person, and serious damage to the instrument. Do not place or use the instrument in a place subject to ventilation.

1-2-5 OPERATION-RELATED WARNINGS

Power Switch

Before plugging the power cord in be sure to check that the power switch is set to off for protection of the instrument.



CAUTION

Ground Connection

When connecting a probe, connect the ground side of the probe to the ground of the signal source. At a floating status, a potential might be produced with respect to other devices or ground, resulting in damaging the instrument, probe, other measuring instruments, etc.

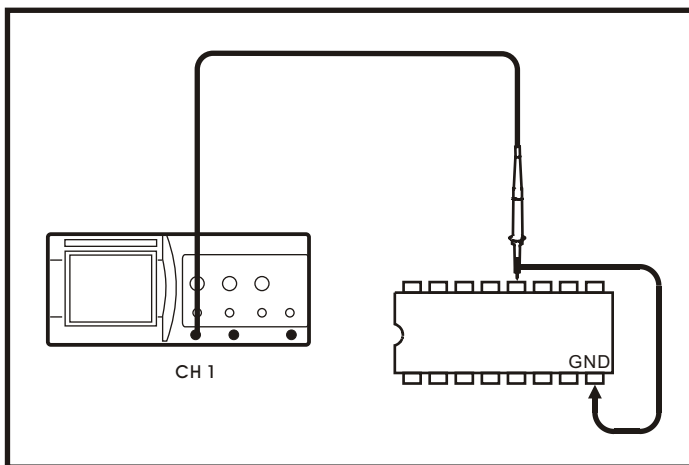

Excessive Input Voltage

In order to avoid electric shock or fire, the input voltages to the probes, BNC connectors are specified as follows. Do not apply higher voltages. Before using probe, check the rated voltage with the naked eye. Remove the unused probe not to contact with ambient high voltage parts. If you apply a higher voltage more than 400Vpk, remove the probe out of BNC terminals to ensure against accidental danger



WARNING

**Maximum input Voltage
- CH1, CH2 all 400Vpk**

Do not Use Non-certified Probes

Use the probes certified according to EN 61010-1 and EN 61010-2-031 in europe.
Use the UL listed probes in america.

1-2-6 SERVICE-RELATED WARNINGS

Damage Requiring Service

Do not attempt to service this instrument yourself as opening or removing covers may expose you to dangerous voltage or other hazards.

Unplug this instrument from the power source and after servicing to qualified service personal under the following conditions



WARNING

- When the AC power cord or plug is damaged.
- When the LCD is damaged, you must not open the cover during operation. There is a risk of electric shock.
- If liquid has been spilled, or objects have fallen into the instrument.
- If the instrument does not operate normally by following the operating instructions. Adjust only those controls that are covered by the operating instructions as an improper adjustment of other controls may result in damage and will open require extensive work by a qualified technician to restore the instrument to instrument to its normal operation.

Unplug the power cord from the power source before opening the cover, and then remove the probe. Even if the instrument is disconnected from all the power sources, special attention is required in service as the inside capacity might be in charged condition. When replacement of fuses or other parts is required, be sure the service technician has used replacements parts specified by the manufacturer or have the same characteristics as the original part. Unauthorized substitutions may result in fire, electric shock or other hazards.



WARNING

There is a risk of electric shock. No user serviceable parts inside. Leave repair to qualified personnel.

Safety Check

Upon completion of any service or repairs to this instrument, ask the service technician to perform safety checks to determine that the instrument is proper operating condition.

1-2-7 CLEANING AND MAINTENANCE

Maintenance routines performable by the operator are listed in this section. More advanced routines (i.e., procedures involving repairs or adjustments within the instrument) should be referred to service personnel.

Cleaning

If the outside of the case becomes dirty or stained, carefully wipe the surface with a cloth moistened with detergent, then wipe the cleaned surface with a dry cloth. In case of severe stain, try cleaning with a cloth moistened with alcohol. Do not use powerful hydrocarbons such as benzene or paint thinner. Dust and/or smudges can be removed from the LCD screen. First remove the front case and filter. Clean the filter (and the LCD face, if necessary) by wiping carefully with a soft cloth or commercial wiping tissue moistened with a mild cleaning agent. Take care not to scratch them. Do not use abrasive cleanser or strong solvents. Let the cleaned parts dry thoroughly before reinstalling the filter and front case. If it is installed wet, dew may form and blur the waveforms. Be particularly careful not to get fingerprints on the filter or LCD face.

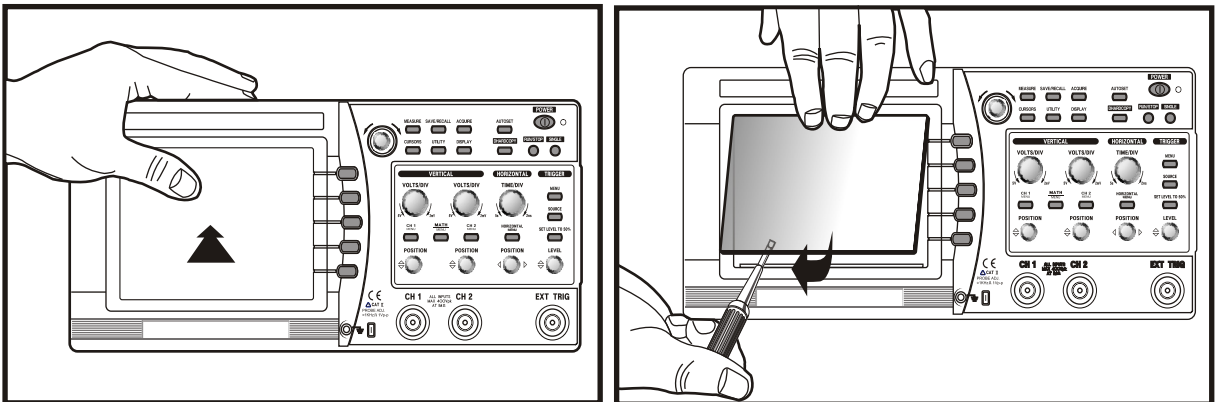

Maintenance

This instrument should never be placed in a built-in installation such as a bookcase or rack unless proper ventilation is provided. Ideal ambient temperature and relative humidity for storing the instrument are 23°C and 60%

1-3 NOTES TO USERS

1-3-1 NOTICE FOR PROPER MEASUREMENT

It is recommended to allow about 15 minutes after power on as warm up time before starting measurement. Traces may drift a little just after power on. When measuring a signal with high accuracy trace declination, you can correct the trace position using the automatic calibration function. Before starting up this function, allow enough warm-up time.

The calibration is classified into software calibration for resorting to the automatic calibration function in the menu, and hardware calibration for optimizing the internal circuitry in a wide range.

1. The software calibration is recommended when the ambient temperature has excessively changed (5°C) or when 1000 operating hours or 6 months has been attained. If the trace is displayed excessively or when it is desired to optimize the measurement, execute it referring to the automatic calibration. Before calibration, disconnect all inputs for accurate adjustment.
2. The hardware calibration is necessary to keep the instrument to a stable operation status. It is recommended to adjust the instrument every 2,000 operating hours or every year.

SOFTWARE CALIBRATION FOR OPTIMUM MEASUREMENT

The changes in measurement accuracy due to use environments (temperature, humidity, etc) can be optimally corrected automatically by activating the calibration. It is recommended to perform calibration when any of the following cases applies.

- **Before a customer starts to use this instrument first**
- **When an ambient temperature changes more than 5°C , compared with that at the time of the previous calibration.**
- **Every 6 months or 1000 operating hours**
- **Optimization of measurement accuracy is required**

1-3-2 WHEN CONNECTING PERIPHERAL DEVICES

When connecting a printer and a personal computer to the oscilloscope, be sure that the oscilloscope, the printer and the personal computer are all off, and then connect them. Pay attention to the direction of the cables and the ports of the peripheral devices. Before operation, be sure to carry out the setting necessary for the printer and the personal computer. (For the setting of the printer and the personal computer, refer to the operation manual for each) If you operate the printer and the personal computer which are improperly set, abnormal operation will occur. In this case, turn off the instrument, the printer and the personal computer at once, and set them properly again and operate them.

NOTE

Before using peripheral devices, Interface card should be installed in this instrument.

When using thermal printer operation, RS-232C settings are as follows

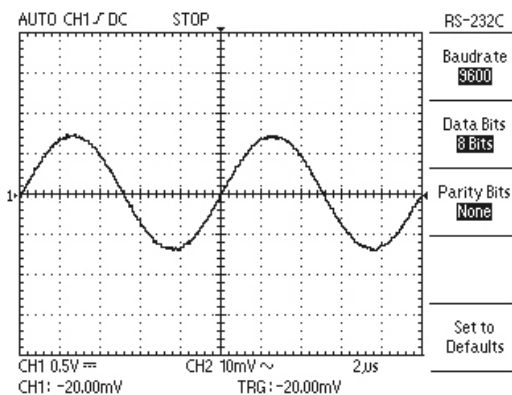

- BAUD RATE : 9600 bps
- PARITY BIT : None
- DATA BIT : 8 bit
- * RS-232C Serial cable is 9pin (male) to 25pin(male) null cable.
- * RS-232C thermal printer is Printy 2™ of SANEI Electric INC

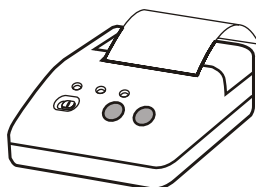
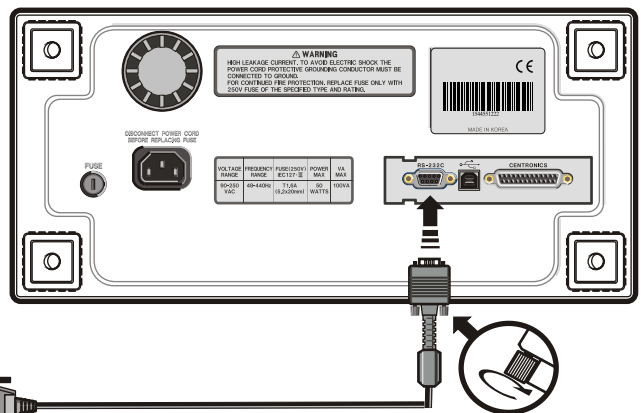
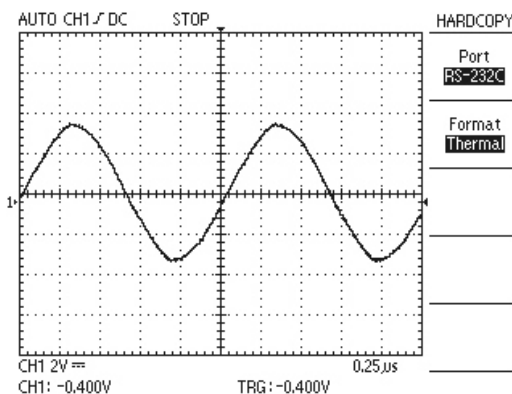

When using printer operation, Centronics settings are as follows

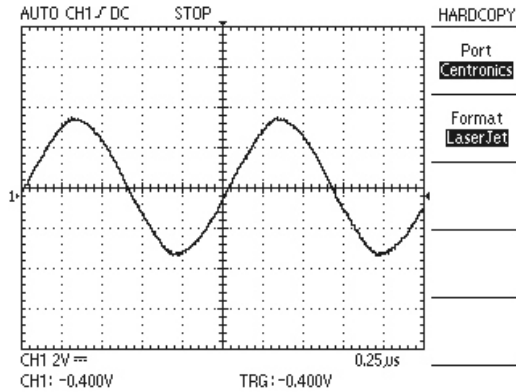

- * This instrument supports DeskJet™ and LaserJet™ with PCL level 3
- * DeskJet™, LaserJet™ is registered trade mark of HP.

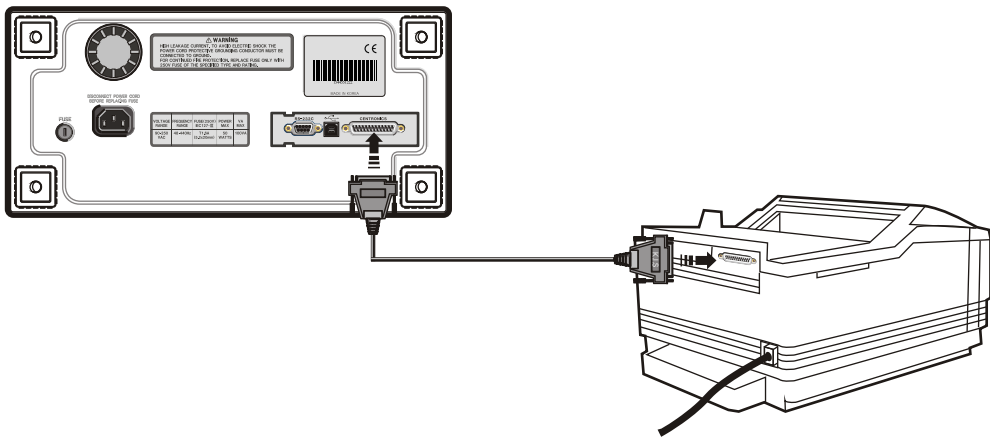

When using PC communication operation, RS-232C settings are as follows

Before communicating with a PC, the PC software kit(option) should be installed in your PC. If you want to have more detailed information, refer to the PC software kit manual.

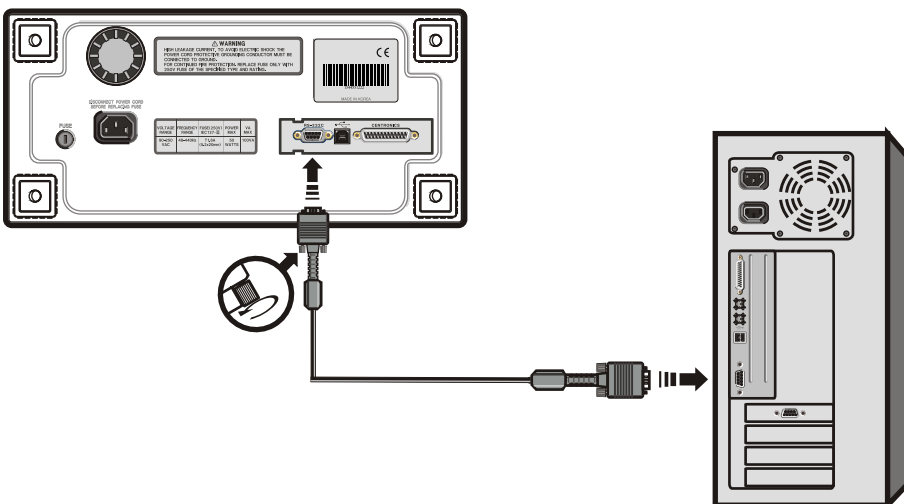

When using PC communication operation, the USB settings are as follows

Before communicating with a PC, the PC software kit (optional) should be installed in your PC, and the interface card with USB should be installed in your instrument. The USB protocol is spec V1.1

For more detailed information, refer to the PC software kit manual.

If users want to connect the instrument with the computer and use it, the port needs to be set to the connection format between them and the transmission format needs to be set to the BMP format.

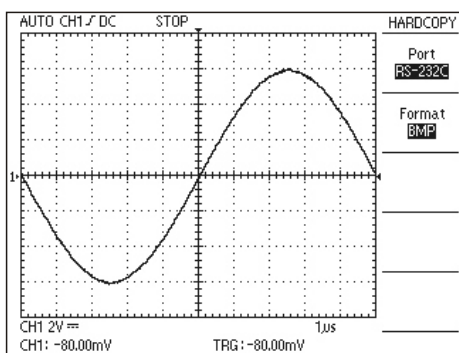
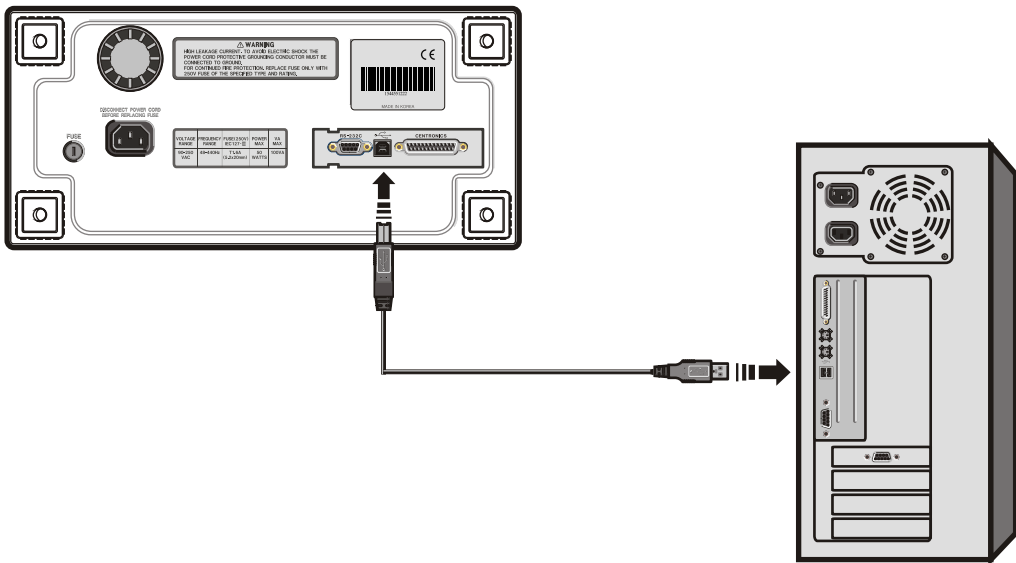

When connected through RS232C

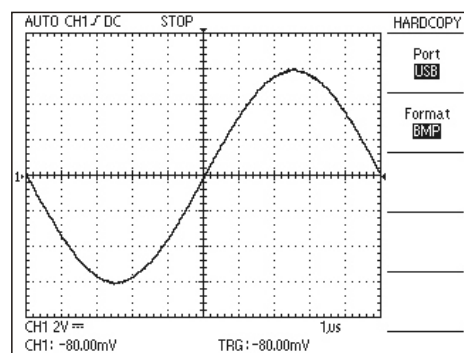

When connected through USB.

1-3-3 PROBE

The first step of measurement is to connect the signals to the instrument properly.

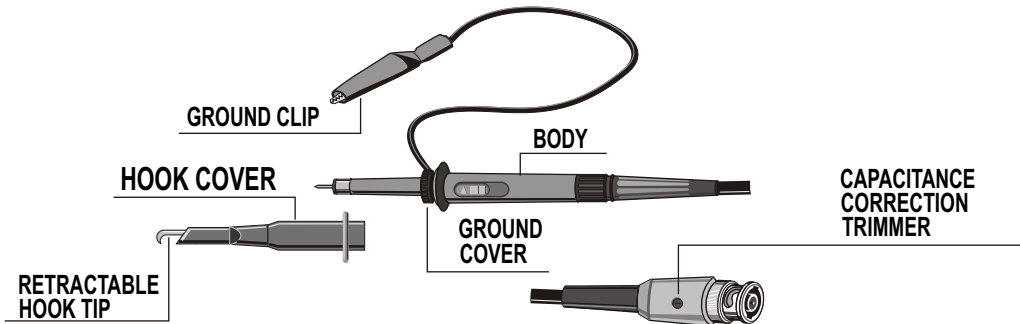

WARNING

Probe Attenuation Setting

When the optional probe is used with the x10 / x1 select switch set to x10, the input signal to the instrument is attenuated to 1/10. When a signal is too small to be measured with x10, use the mode x1. In this case, note that the input impedance of x1 is different from that of x10, and the measurable frequency band becomes very low.



Probe Grounding

Connect the probe ground lead as close as possible to the point being measured especially when measuring a signal with a fast rise time or a high frequency signal. Long probe ground leads may cause waveform distortions, such as ringing and overshoot.

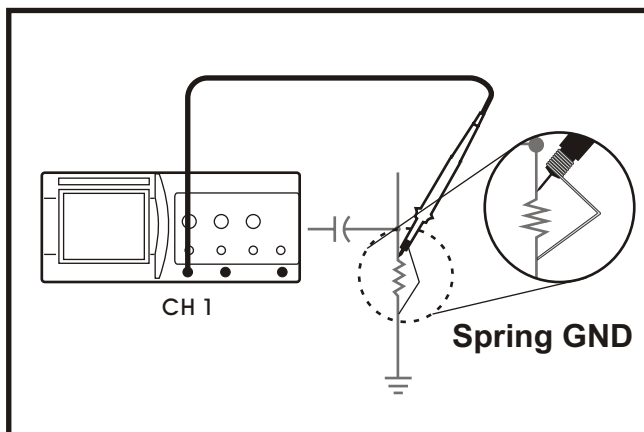

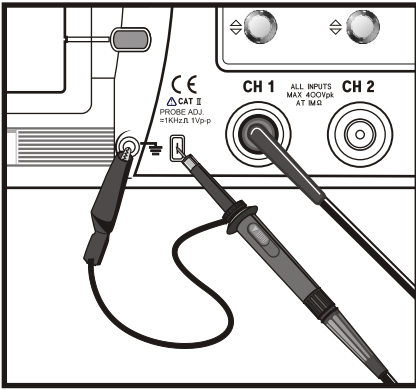

Probe Compensation

The probe switch setting is 10X.

To avoid a measurement error, probe compensation must be done. Especially when the probe is charged.

Connect the probe tip to the CAL 1V output terminal. A 1 kHz square wave should be displayed with flat tops.

Any distortion in the left presentation is caused by incorrect probe compensation.

If overshoot or undershoot is present, turn the screwdriver adjustment in the probe for a flat-top presentation.

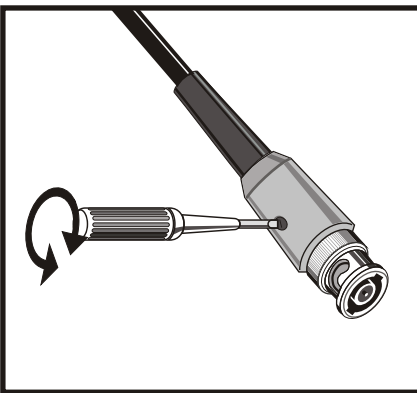

This adjustment remains in effect until changed again.

Be sure that the attenuation switch on the probe is set to match with the probe menu selection in the oscilloscope.

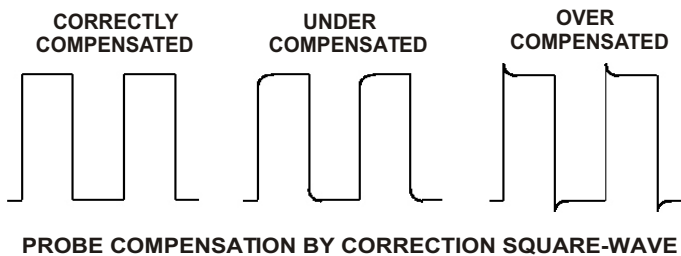

1-4 INSTALLATION



CAUTION

1-4-1 POWER CORD

Use only power cords designed for your oscilloscope. Use a power source that delivers 90 to 250 V_{ACRMS}, 48 to 440 Hz.

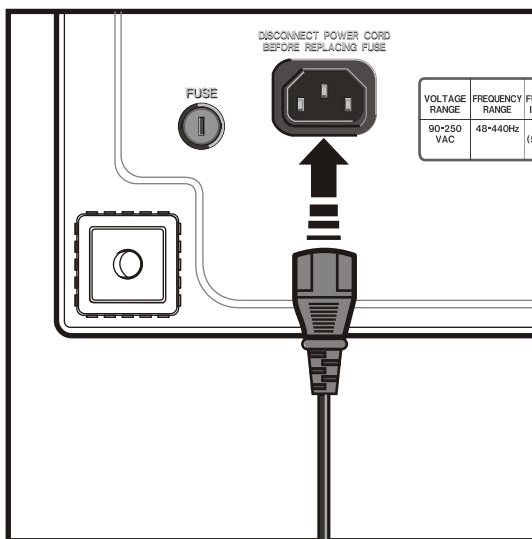

1-4-2 INTERFACE CARD

You can increase the feature set of your oscilloscope by inserting an interface card.

Refer to the "NOTES TO USERS" section in this manual and the PC software Kit manual for detailed description. Install the interface card into the rear of DS-1000 series as following procedures.

Two types of interface card (optional) are available. Be sure of which one you need when you place an order.

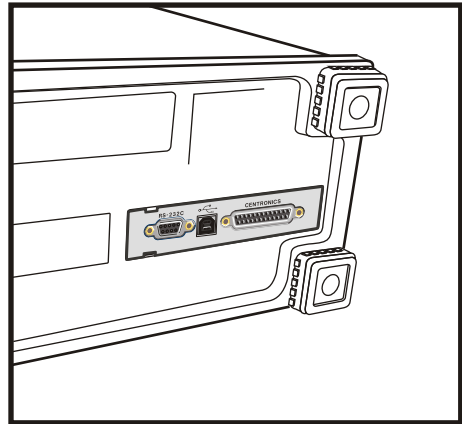
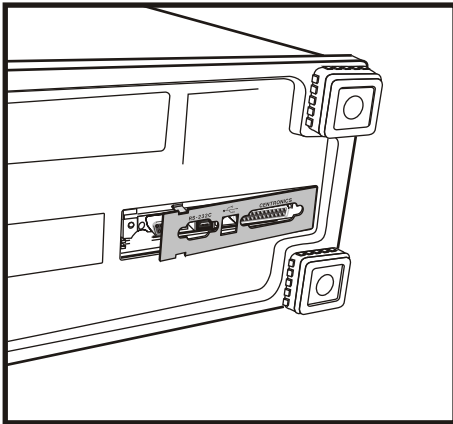
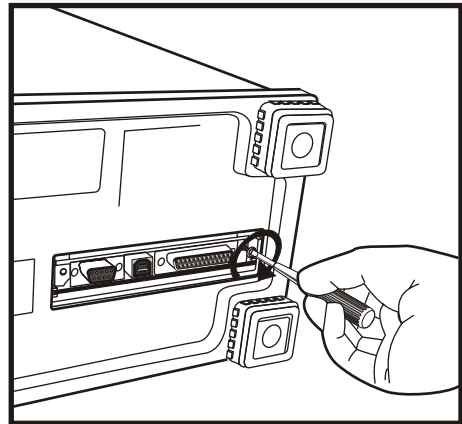
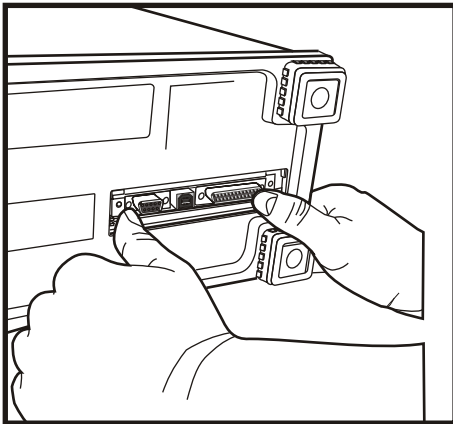
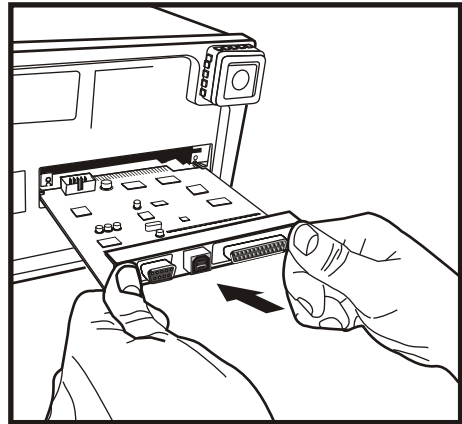
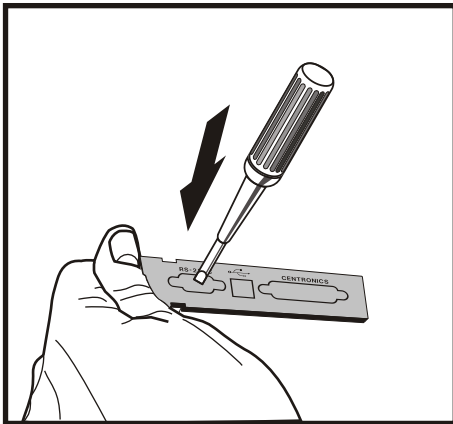
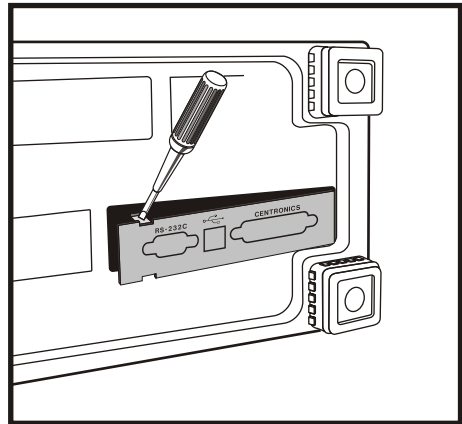
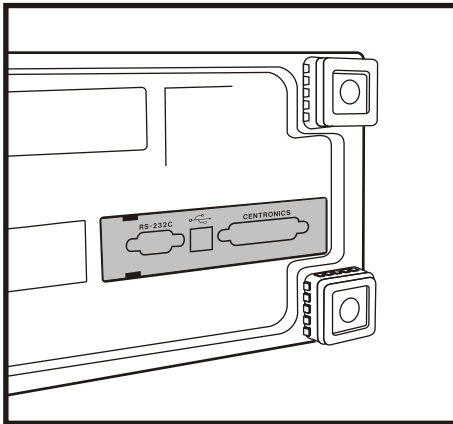

2. DESCRIPTION

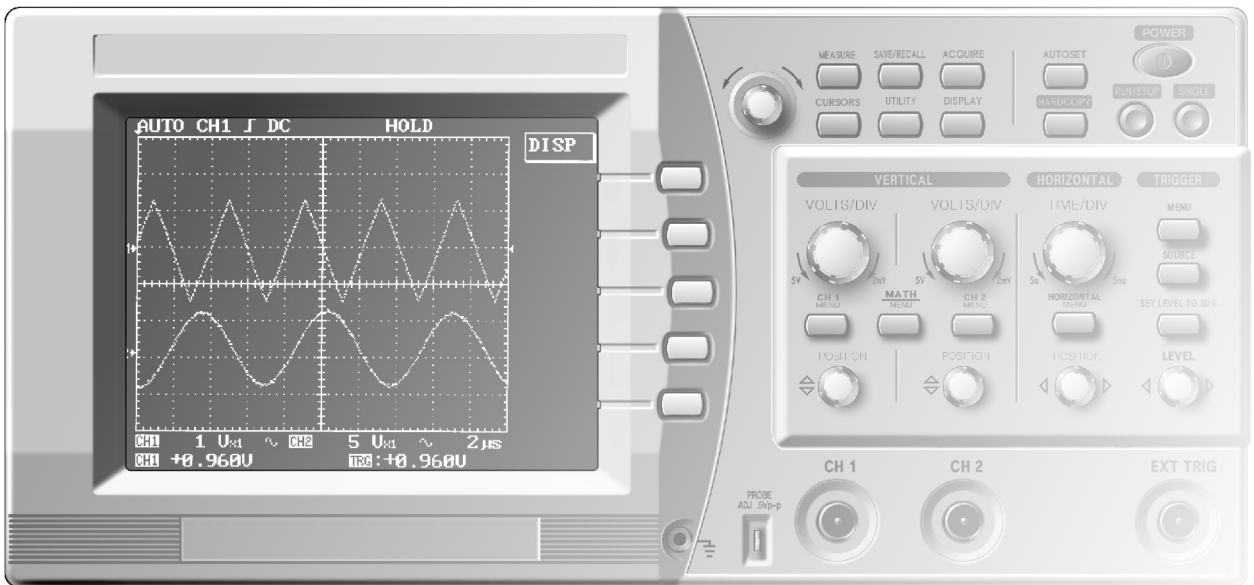

2-1 KEY & DISPLAY DESCRIPTION

2-1-1 DISPLAY OVERVIEW

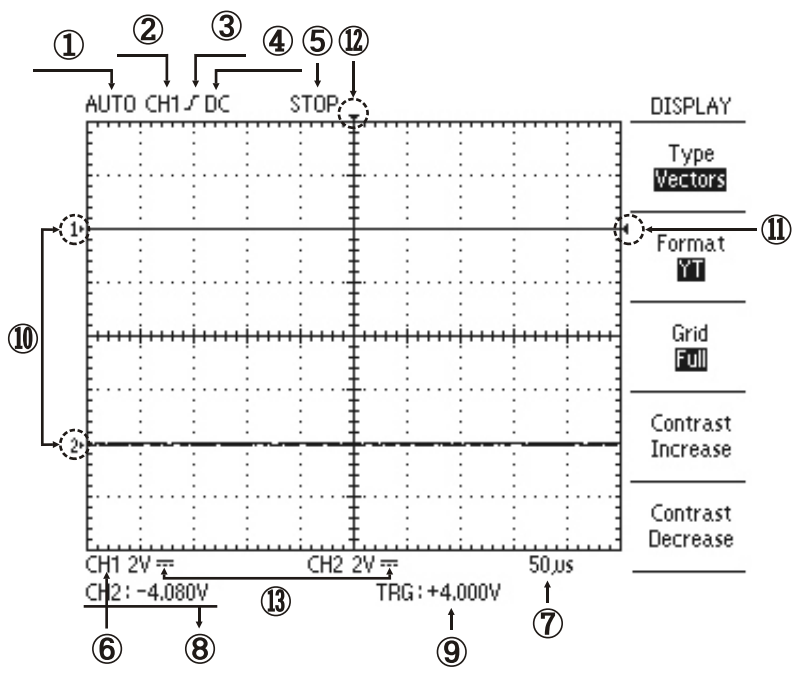

- 1. TRIGGER MODE.
- 2. TRIGGER SOURCE.
- 3. TRIGGER SLOPE.
- 4. TRIGGER COUPLING MODE.
- 5. RUN / STOP.
- 6. CH VOLTS / DIVISION.
- 7. TIME / DIVISION.
- 8. VERTICAL POSITION VALUE.
- 9. TRIGGER LEVEL VALUE.

10. CH1 / CH2 POSITION CURSOR.

11. TRIGGER LEVEL CURSOR.

12. HORIZONTAL TRIGGER POSITION.

13. INPUT COUPLING MODE.

2-1-2 VERTICAL AXIS OPERATION

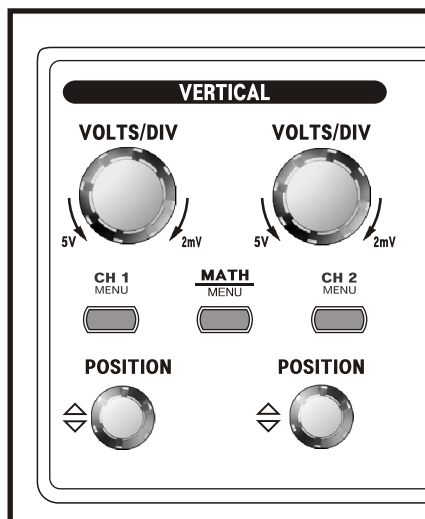

VOLTS/DIV (CH1, CH 2). Adjusts vertical scale factor of the scope waveform.

CH 1, CH 2 MENU. Shows the channel function and channel waveform display on and off.

MATH MENU. Shows the math function.

CH 1, 2 POSITION. Adjusts vertical position of the scope waveform.

2-1-3 HORIZONTAL AXIS OPERATION

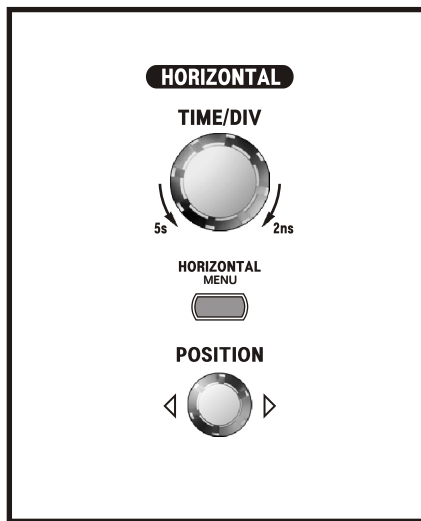

TIME/DIV. Adjusts horizontal axis scale factor of the scope.

HORIZONTAL MENU. Shows the horizontal function.

POSITION. Moves horizontal axis position of the scope.

2-1-4 TRIGGER

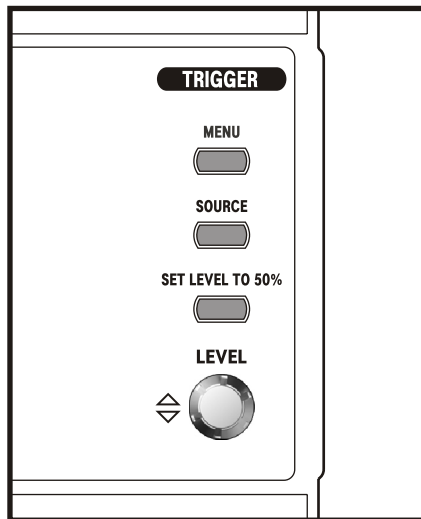

TRIGGER MENU. Adjust the trigger mode.

TRIGGER SOURCE. Select the trigger signal source.

SET LEVEL TO 50%. Set the trigger level to the middle of the scope waveform.

TRIGGER LEVEL. Selects a starting point of triggered signal.

2-1-5 MENUS

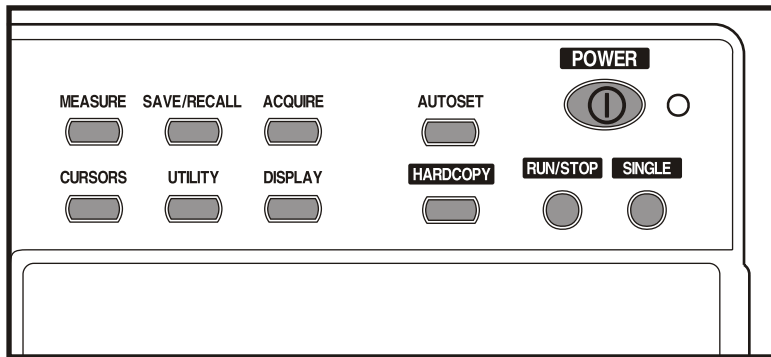

MEASURE. Controls the measurement functions.

SAVE/RECALL. Controls the save/recall functions.

ACQUIRE. Controls the acquire mode.

CURSORS. Controls the cursor functions.

UTILITY. Sets the utility functions.

DISPLAY. Sets the display mode.

AUTOSET. Automatically displays the optimum waveform of input signals.

HARDCOPY. Prints the waveform.

RUN/STOP. Controls the waveform acquisition.

SINGLE. Captures a non-periodic signal and a long-periodic signal.

2-1-6 CONNECTORS

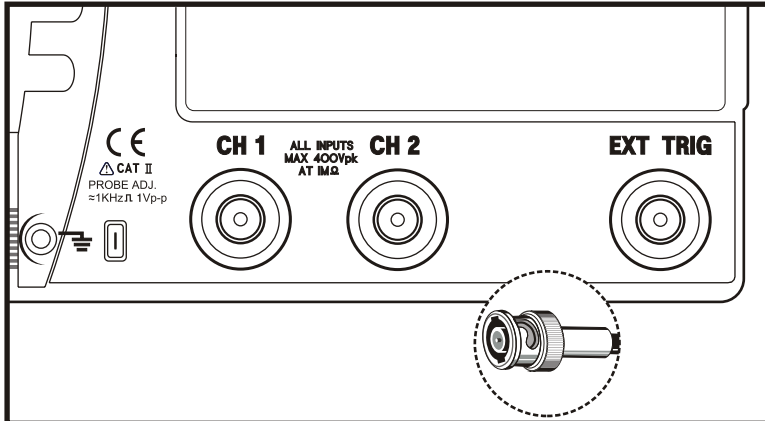

PROBE ADJ.

This outputs square wave (1V, 1kHz) for the probe compensation.

CH 1, CH 2.

Connects input signal to the channel vertical amplifier. CH1 becomes a signal of X-axis during X-Y operation and CH2 becomes a signal of Y-axis during X-Y operation.

EXT TRIG.

Connects an external trigger signal to the trigger circuit.

2-1-7 THE MENU BOX BUTTON AND FUNCTION KNOB

When you press a menu button on the front panel, the associated menu title displays at the top right screen. There can be up to five menu boxes below the menu title. To the right of each menu box is a bezel button you can use to change the menu setting.

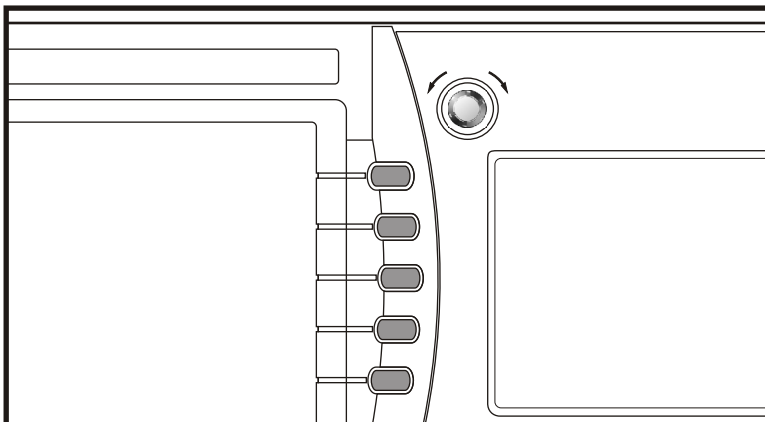

2-2 MENUS

2-2-1 AUTOSET

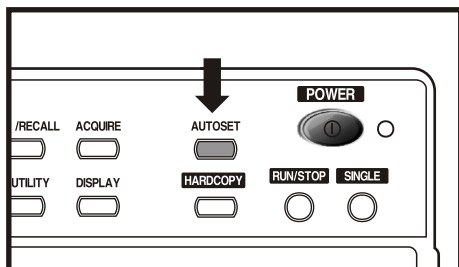

AUTOSET

The front panel settings are automatically performed so that the optimum waveform is displayed for an input signal and changes itself in succession. With this function, the following items can be automatically set according to the characteristics of an input signal.

Function	Setting
Vertical coupling	AC
Trigger type	Edge
Trigger coupling	Adjusted to DC
Trigger slope	Rising
Trigger mode	Auto

Condition

The autosegment function is available only for a stable, repetitive input signal. For a stable operation, an input signal is essential to meet the following conditions.

- a) Frequency : 50Hz ~ maximum bandwidth, typical
- b) Amplitude : more than 60mV

NOTE

If these conditions are not satisfied, the following message is displayed below the screen : " Unable to autosegment "

2-2-2 VERTICAL

Following description on switches are applied to both CH1 And CH2 equally.

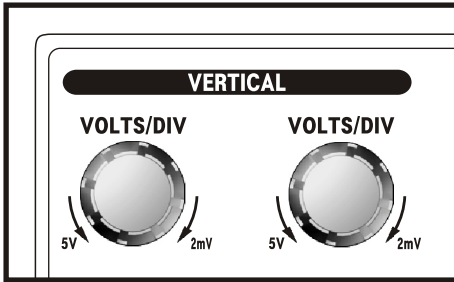

VOLTS/DIV

The vertical axis sensitivity can be set by the VOLTS/DIV switch of the Ch1 and CH2.

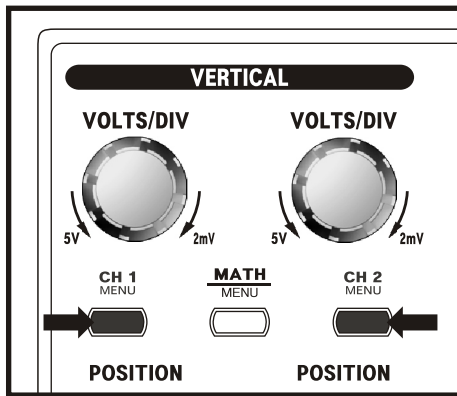

MENU

There is a separate vertical menu for each channel. Each item is set individually for each channel.

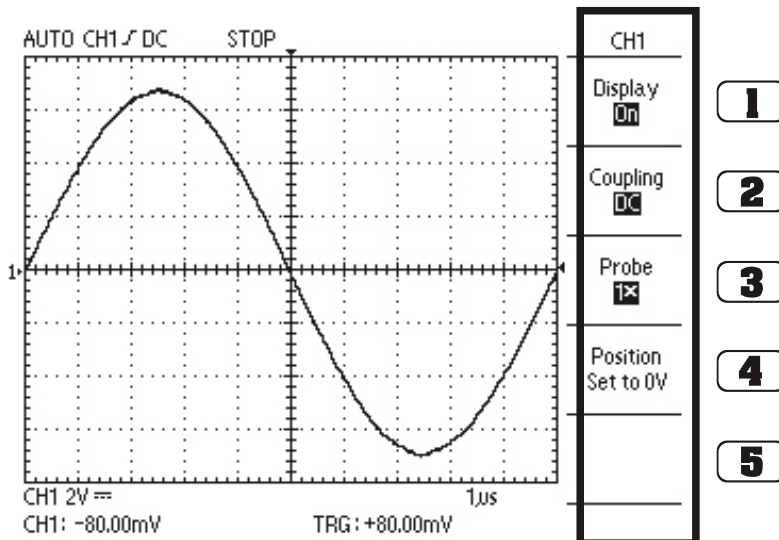

1)Display. (On/Off) : CH1 or CH2 is selected and displayed by pressing this switch, and both channels can be selected and displayed at the same time. Whenever this switch is pressed, channel display function is operated repeatedly.

2)Coupling. (AC/DC/Ground) : Three input coupling modes are available. Select the desired coupling mode by the DC/AC/GND switch. The selected coupling mode is displayed at the bottom left of the screen. Whenever the switch is pressed, coupling of input signal is operated in the sequence of AC, DC and Ground.

AC : Displayed on the screen in the form of " \sim ". An input signal is connected to the amplifier via a capacitor. Its DC component is cut and only AC component is displayed.

DC : Displayed on the screen in the form of " \equiv ". An input is directly connected to the amplifier, and the signal including a DC component is displayed.

Ground : Displayed on the screen in the form of " ⏏ ". An input signal is separated and the input of the vertical amplifier is grounded.

3)Probe . (X1 / x10 / x100 / x1000) : Set this to match your probe attenuation factor to make the vertical scale readout correct

x1 : when 1:1 probe is used or signal is directly connected to the coaxial cable, x1 is selected

x10 : when 10:1 probe is used , x10 is selected.

x100 : when 100:1 probe is used, x100 is selected.

X1000 : when 1000:1 probe is used , x1000 is selected.

4)Position Set To 0

Set the offset to 0V. Offset performs a function similar to the vertical position knob.

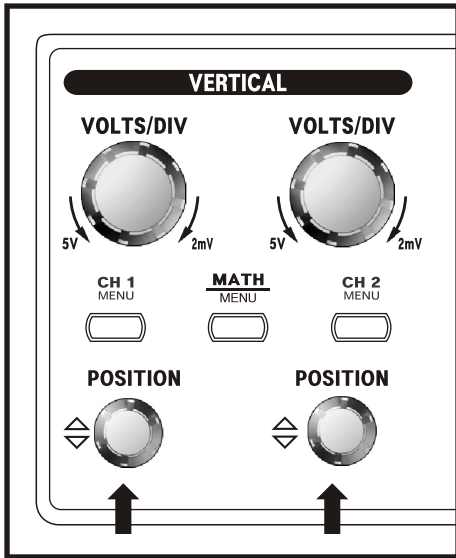

POSITION

The displayed waveform can be moved up and down by the position knob.

When the knob moves to right, waveform moves down and when the knob moves to left, waveform moves up.

2-2-3 MATH

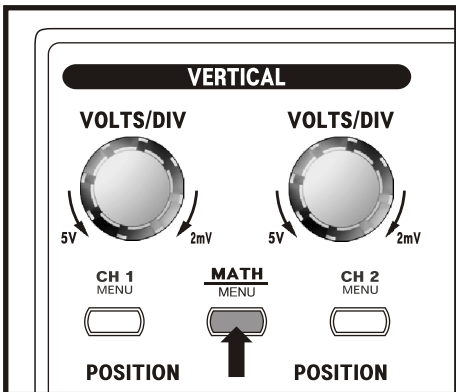

MATH

When this switch is pressed, arithmetic and advanced function are displayed.

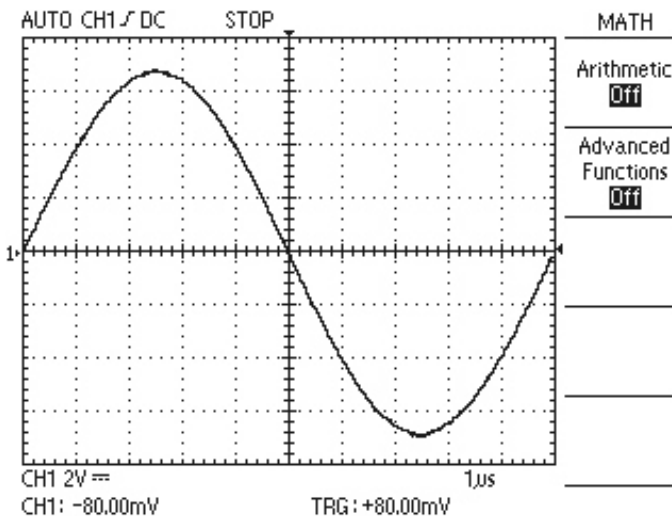

1) Arithmetic

(Off/Ch1+Ch2/Ch1-Ch2/Ch2-Ch1/Ch1 Invert/Ch2 Invert)

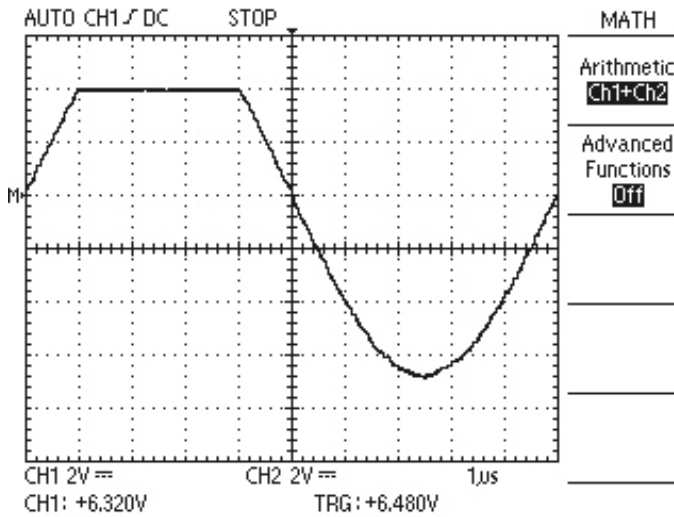

Addition, subtraction and inversion arithmetic of the two channels are able to be carried out to Ch1 or Ch2 by Arithmetic.

Off : This cancels the arithmetic function.

Ch1 + Ch2 : This displays a waveform which adds signals of two channels.

Ch1 - Ch2 : This displays a waveform which subtracts Ch2 from Ch1.

Ch2 - Ch1 : This displays a waveform which subtracts Ch1 from Ch2.

Ch1 Invert : This displays an inversed waveform signal of Ch1.

Ch2 Invert : This displays an inversed waveform signal of Ch2.

Displaying a math waveform automatically removes the display of channels used to create the math waveform. Math operations are turned off if a channel used in the operation is turned on.

2) Advanced Functions(Off/Pass-Fail/FFT)

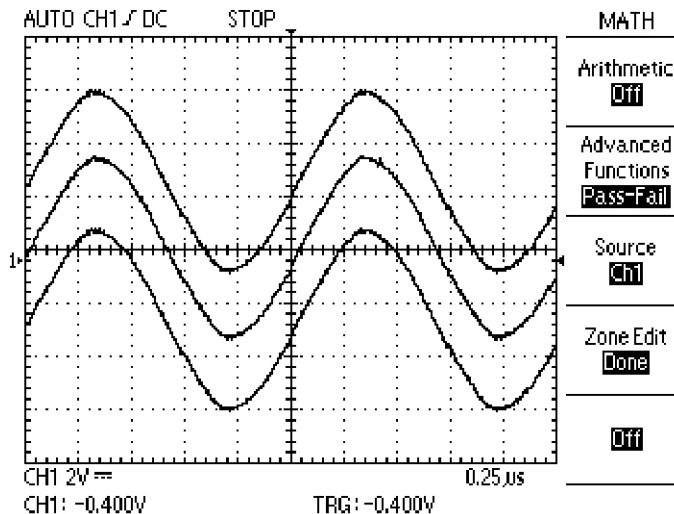

Off : This cancels the Advanced functions.

Pass-Fail : User sets the judgement range of Pass-Fail displayed on the screen and compares it with acquired waveforms. When this menu is selected, submenu On, Off, Ch1, Ch2 and Edit are displayed. This function is automatically canceled when XY format display is operated, AUTOSET is operated, Measure menu is operated, ROLL mode is operated, Arithmetic function is operated or Cursor function is operated.

Source (Ch1/Ch2)

Ch1 : Be selected judgement area as "to be edited signal source" and "to be compared signal source".

Ch2 : Be selected judgement area as "to be edited signal source" and "to be compared signal source".

Zone Edit (Off/Upper Side/Lower Side/Done)

Off : This clears all judgement area currently set on the screen and cancels comparing function. But the data in the memory are not cleared.

Upper Side : This decides to be edited portion from upper portion of the waveform. The edited portion be adjusted to use function knob. And it only moves to the upper side of the reference waveform. This mode don't use the others menu except the function knob.

Lower Side : This decides to be edited portion from lower portion of the waveform. . The edited portion be adjusted to use function knob. And it only moves to the lower side of the reference waveform. . This mode don't use the others menu except the function knob.

Done : This performs a operation of comparing judgement area set by user with acquired waveform. When acquired waveform is in judgement area, RUN is maintained, and when acquired waveform is get out of the judgement area, STOP is displayed and waveform is stopped. When comparing function is necessary again, maintain RUN by pressing RUN/STOP switch. The waveform is regenerated when selecting On after setting Off

Off/On

Off : Selects not to activate PASS-FAIL function.

On : Selects to activate PASS-FAIL function.

FFT

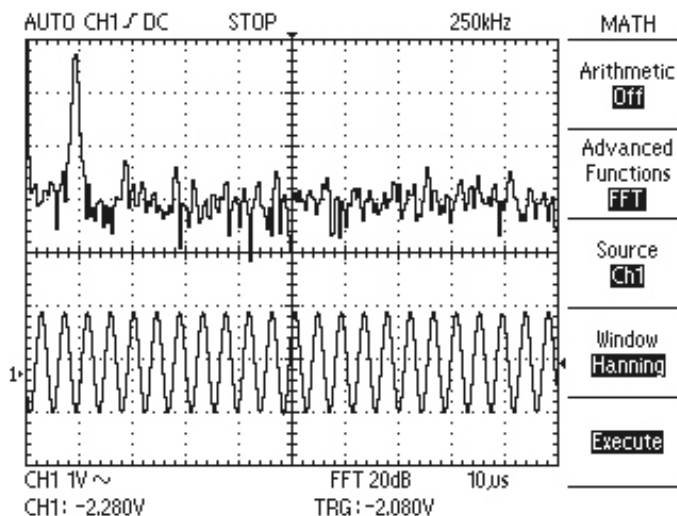

This allows acquired waveforms to be converted into frequency-domain traces, revealing valuable spectral information that would otherwise be impossible to detect on a time-domain record.

Source(Ch1/Ch2)

Ch1 : Ch1 is selected source as to be transformed FFT.

Ch2 : Ch2 is selected source as to be transformed FFT.

Window(Rectangle/Hamming/Hanning)

Rectangle : Transforms to rectangular mode.

Hamming : Transforms to hamming mode.

Hanning : Transforms to hannig mode.

Execute/Calculating

Execute : Calculates the FFT. After calculate, display of the waveform is stopped.

Calculating : Displays the status of calculating.

2-2-4 HORIZONTAL

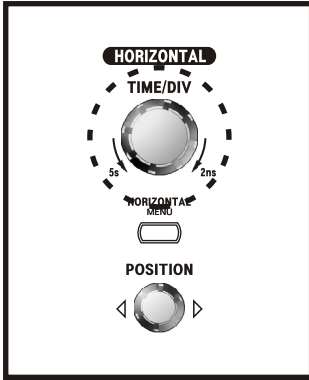

TIME/DIV.

A time axis range can be set by the TIME/DIV knob. When the knob turn to 5s, TIME/DIV is slow in and turn to 2ns, TIME/DIV is fast in.

MENU

Set the horizontal menu

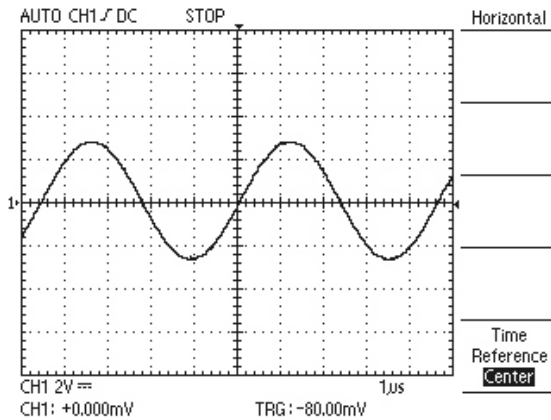
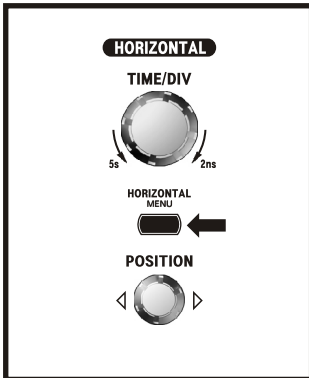

Time Reference (Center/Right/Left)

Control position of horizontal trigger.

Center : Set the position of horizontal trigger to the center of screen.

Right : Set the position of horizontal trigger to the right of screen.

Left : Set the position of horizontal trigger to the left of screen.

POSITION

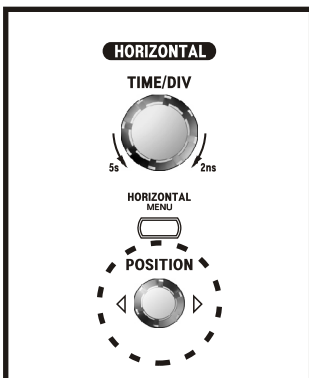

Displayed waveform can be moved left and right.

2-2-5 TRIGGER

MENU

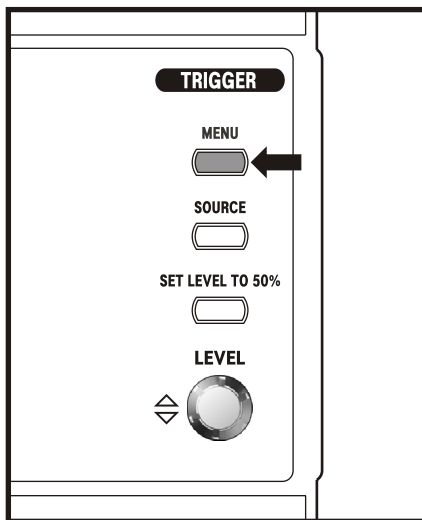

Two types of triggering are available: Edge and TV. A different set of menus display for each trigger type.

1)Type(Edge/TV) : Edge

Use edge triggering to trigger on the edge of the input signal at the trigger threshold.

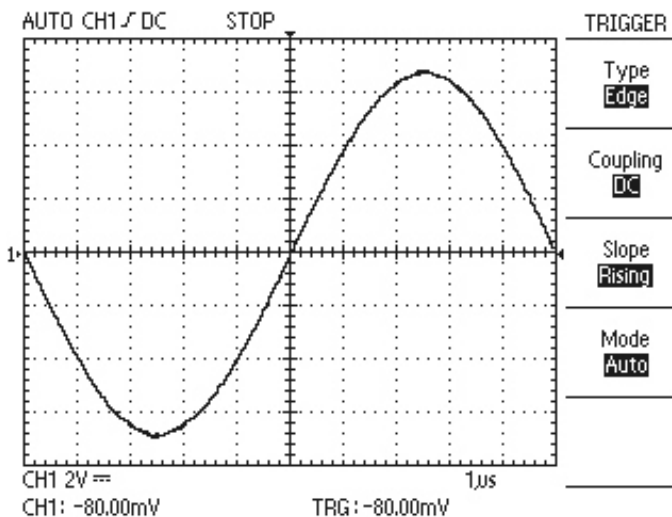

Coupling(AC/DC/HF Reject/LF Reject) : This function decides which part of the signal is transferred to the trigger circuit. That is, desired coupling type is selected between trigger source signal and trigger circuit by this switch. When coupling switch is pressed, AC, DC, HF Reject and LF Reject are displayed in sequence.

AC : Only AC component is passed through in the signal and DC component is removed from the trigger signal.

DC : Trigger signal which includes DC signal is coupled. Trigger is applied when DC level of signal intersects with setting trigger level.

HF Reject (High frequency rejection) : This function interrupts a high frequency component of triggering signal. So, only the low frequency component is passed through triggering system and then captured. Interruption of high frequency reduces a signal with 300kHz or more.

LF Reject (Low frequency rejection) : This function interrupts low frequency component of triggering signal. Interruption of low frequency reduces a signal with 1kHz or less.

Slope(Rising/Falling) : This function decides at which place the trigger point is found out, rising edge or falling edge. This function displays a status of slope setting behind "coupling". Screen display of rising edge is "┌" and falling edge is "└"

Mode(Auto/Normal/Single) : When MODE function is pressed, AUTO, NORM and SINGLE are displayed in sequence. Setting of trigger mode is displayed at the top left of the screen.

Auto : Without trigger, waveform is able to be captured by this function. When AUTO mode is triggered forcibly without triggering, note that it is not synchronized with the waveform of display. In other words, successive capture is not triggered at same point on display. Therefore, waveform seems to cross and roll on the screen.

Normal : When Trigger is operated, oscilloscope is able to capture the waveform by this function. Without trigger, oscilloscope does not capture the waveform.

Single : Trigger is able to be operated with NORM mode. However, when trigger is operated in long period or non-periodic signal, it is in the status of STOP, and when trigger is not operated, oscilloscope is in stand-by status until the trigger is restarted.

2)Type(Edge/TV) : TV

Use TV triggering to trigger on the TV signal.

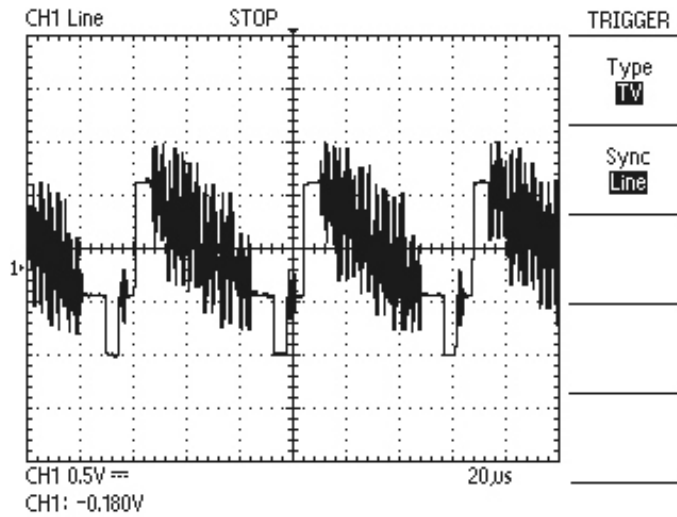

Sync(Line/Field)

Line : This function is solely used in the observation of TV signal and trigger is applied to horizontal synchronization signal.

Field : Trigger is applied to vertical synchronization signal.

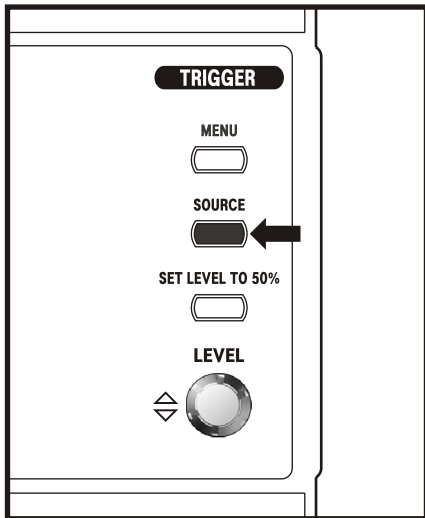

SOURCE

With this function, Trigger is able to be selected from the source such as CH1, CH2, EXT or LINE. The channel which is selected as trigger source performs a function of trigger source without connections with display. After the display of "mode setting", source setting is displayed on screen.

CH1 : Input signal of CH1 is used as trigger source.

CH2 : Input signal of CH2 is used as trigger source.

EXT : When trigger is operated with signals from external clock or other parts of the circuit, or in case an auxiliary trigger is used, connect the external trigger signal to the EXT terminal.

LINE : The LINE trigger source uses the line voltage signal as the trigger source.

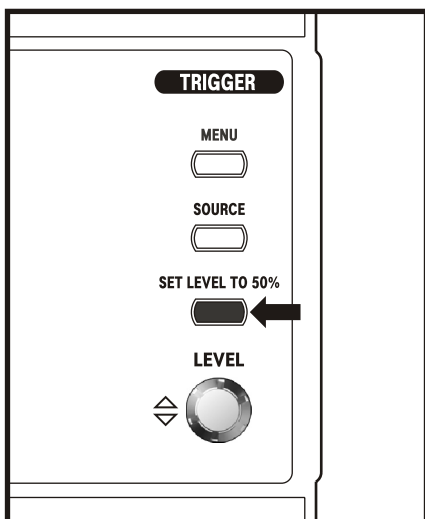

SET LEVEL TO 50%

This function automatically sets a trigger source signal within the 50% of trigger level range. When trigger coupling is AC or LF Reject, the 50% of trigger level is set at the center of GRID vertical axis. When trigger coupling is DC or HF Reject, it is set at the 50% of trigger source signal amplitude.

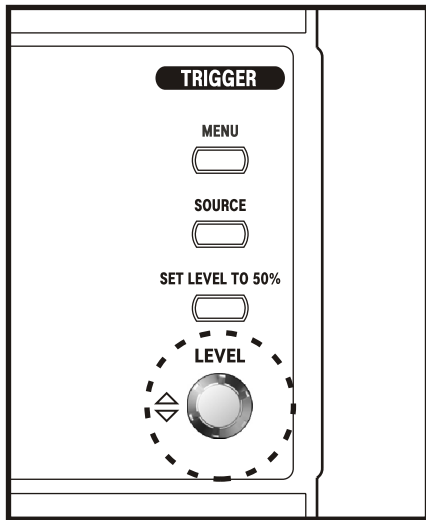

LEVEL

With this function, trigger level is adjusted to the signal level before entering into triggering. Trigger point decides a occurring point on edge. When the knob turn to the right, edge level moves up and turn to the left, edge level moves down.

2-2-6 MEASURE

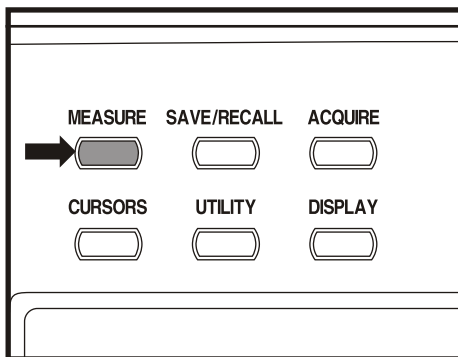

MEASURE

Push the MEASURE button to access the automated measurement capabilities. It has the ability to display up to five parameters at a time. When this menu is selected, submenu NONE, Pk-Pk, RMS, Mean, Frequency, Rising Time, Falling Time, Period, +Width, -Width and Duty are displayed.

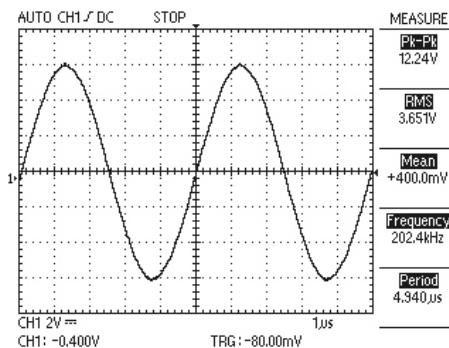

NONE : This cancels the measuring functions of parameter.

Pk-Pk : This displays a Peak to Peak value of the waveforms of the currently displayed channels. That is, absolute gap between maximum and minimum amplitude is displayed with volt. When input signal is out of the ADC input range, "?" is displayed.

Maximum value and minimum value are equal, "Invalid" is displayed.

RMS : This displays a Root Mean Square value of 1 cycle of the waveforms of currently displayed channels. When range of input signal is out of the ADC input range, peak to peak value is less than 2 division, or width of 1 cycle is less than 0.4 division on display, "?" is displayed. When 1 cycle is not captured, "Invalid" is displayed.

Mean : This displays a mean value of 1 cycle of currently displayed waveforms. When range of input signal is out of the ADC input range, peak to peak value is less than 2 division, or width of cycle is less than 0.4 division on display, "?" is displayed. When 1 cycle is not captured, "Invalid" is displayed.

Frequency : This displays a frequency value of 1 cycle of currently displayed waveforms. When range of input signal is out of the ADC input range, peak to peak value is less than 2 division, or width of 1 cycle is less than 0.4 division on display, "?" is displayed. When 1 cycle is not captured, "Invalid" is displayed.

Rising Time : This displays a rising time of currently displayed waveforms. When range of input signal is out of the ADC input range, peak to peak value is less than 2 division, or width of 1 cycle is less than 0.4 division on display, "?" is displayed. when 1 cycle is not captured, "invalid" is displayed.

Falling Time : This displays a falling time of currently displayed waveforms. When range of input signal is out of the ADC input range, peak to peak value is less than 2 division, or width of 1 cycle is less than 0.4 division on display, "?" is displayed. When 1 cycle is not captured, "Invalid" is displayed.

Period : This displays a period of 1cycle of currently displayed waveforms. When range of input signal is out of the ADC input range, peak to peak value is less than 2 division, or width of 1 cycle is less than 0.4 division on display. When 1 cycle is not captured, "Invalid" is displayed.

+ Width : This displays a positive width of 1 cycle of currently displayed waveforms. When range of input signal is out of the ADC input range, peak to peak value is less than 2 division, or width of 1 cycle is less than 0.4 division on display, "?" is displayed. When 1 cycle is not captured, "Invalid" is displayed.

- Width : This displays a negative width of 1 cycle of currently displayed waveforms of channel. When range of input signal is out of the ADC input range, peak to peak value is less than 2 division, or width of 1 cycle is not captured, "Invalid" is displayed.

Duty : This displays a duty ratio of 1 cycle of currently displayed waveforms of channel. When range of input signal is out of the ADC input range, peak to peak value is less than 2 division, or width of 1 cycle is less than 0.4 division on display, "?" is displayed. When 1 cycle is not captured, "Invalid" is displayed.

2-2-7 SAVE/RECALL

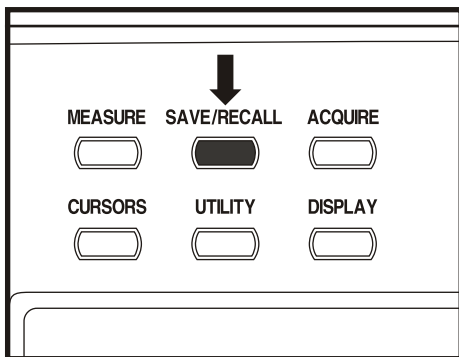

SAVE/RECALL

This function is able to save waveforms and setup conditions of present working environment and they can be recalled by the user. It is used in setting simple working environment and for waveform comparison. The saved information could be preserved for a time even if the inside battery is completely discharged or disconnected from the main body.

1)Type(Setup/Waveforms) : Setup

This operates the function to save present working condition into memory space.

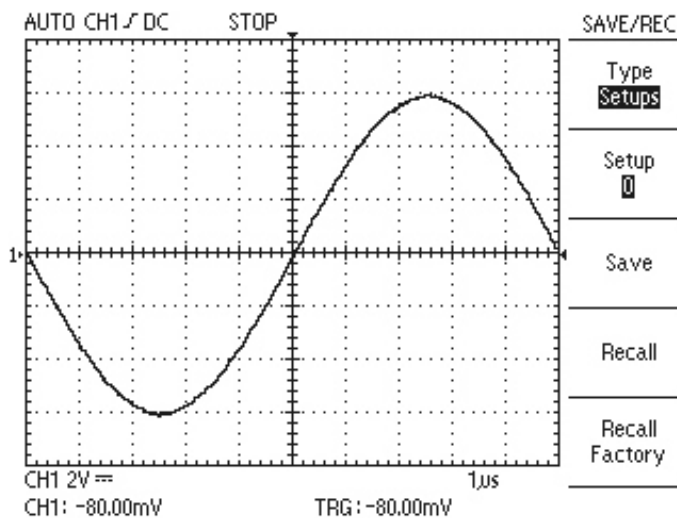

Setup(0/1/2/3/4/5/6/7/8/9) : The menu displays the memory space to save information, and it is able to save upto 10 seup conditions They don't be overlapped with memory space for waveforms.

Save : The saved setup information includes the conditions of input coupling, display, volts division, trigger mode, trigger coupling, trigger source, trigger slope, trigger level, cursor information, probe factor, LCD brightness, display format, display type, acquisition type and interface card setup.

Recall : Recalls the instrument settings stored in the location chosen in the setup space.

Recall Factory: You can recall the default Factory Setup to initialize the instrument to a known setup.

2)Type(Setup/Waveforms) : Waveforms

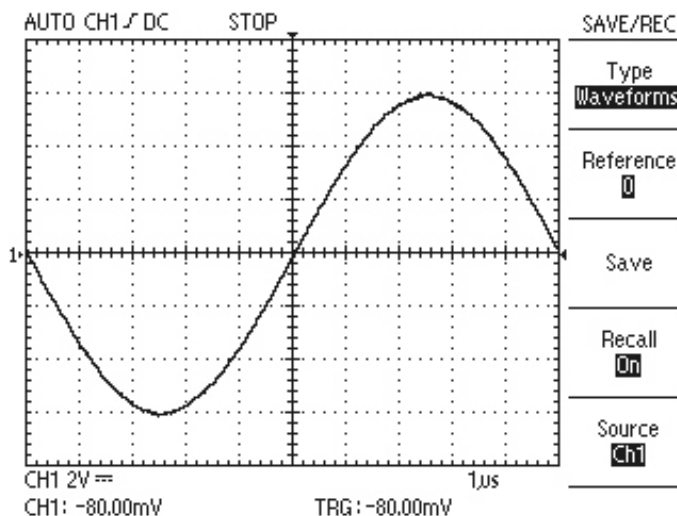

This operates the function to save waveform being displayed at present into memory space.

Reference(0/1/2/3/4/5/6/7/8/9) : This function displays the memory space to save waveforms, and it is able to save 10 waveforms . The memory space don't be overlapped with that for setup condition.

Save : Stores the source waveform to the chosen reference location.

Recall : Turns the reference waveform display on or off.

On : you will be in the mode from which the waveform was saved.

Off: This menu operates to cancel present displayed waveforms and to return to the former waveforms.

Source(Ch1/Ch2) : Choose the waveform source to store.

2-2-8 ACQUIRE

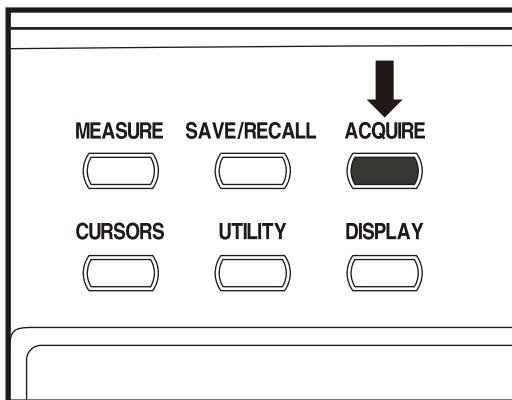

ACQUIRE

Push the ACQUIRE button to set acquisition parameters.

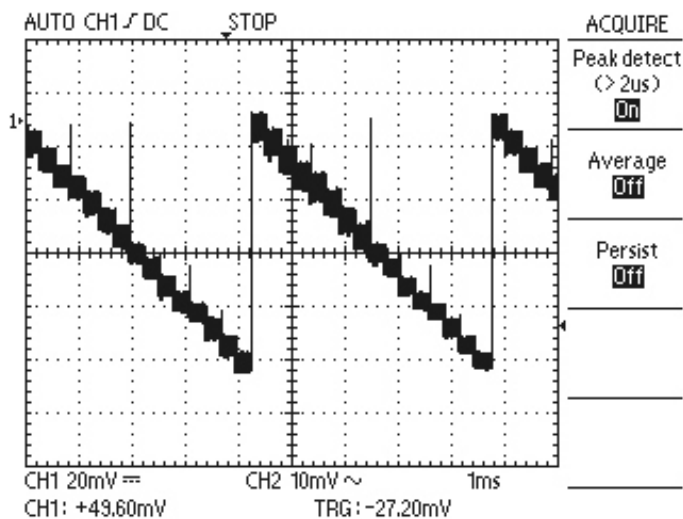

1) Peak detect(Off/On)

Off : Cancels the peak detect mode.

On : Acquires the peak value of the input signal. This mode is able to detect glitches.

2) Average(Off/2/4/8/16/32/64/128)

In this mode, next signal is doubled as much as the reciprocal number of average frequency from the current signal. This mode is used to reduce a distortion of display resulting from noise in signal. The numbers next to Avg are weighted value.

3)Persist(Off/On)

Refresh or overwrite mode is able to be selected by Persist.

Off : This selects refresh display mode. In this mode, only the newly acquired data are displayed.

On : This selects overwrite display mode. In this mode, newly acquired data are displayed upon previously acquired data. This mode is used to observe noise of signal, etc.

2-2-9 CURSORS

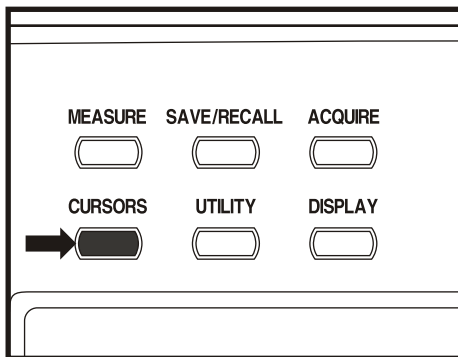

CURSOR

The user can operate the cursor by himself and measure the voltage or time of displayed waveform. These functions can be stopped or canceled automatically in the modes of MEASURE, PASS-FAIL setting, XY format.

1)Type(Off/Voltage/Time)

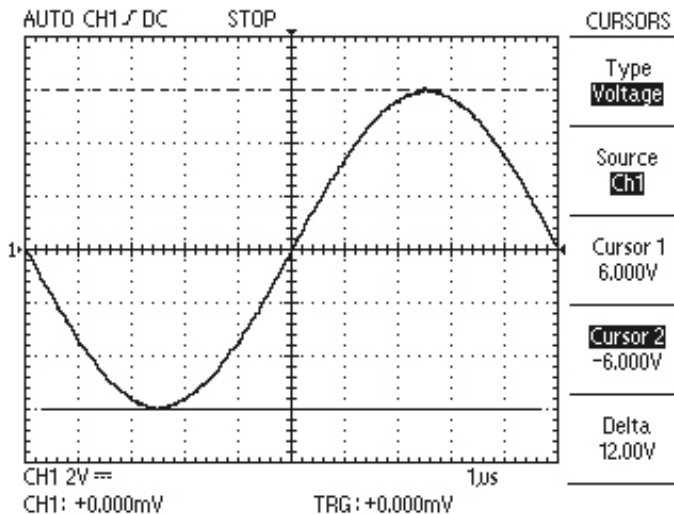

This is used to set the type and on/off mode of cursor. Pressing this button, OFF, Voltage and Time are changed in sequence. At every time, present measuring value is showed up at the menu display.

Off : This cancels the cursor mode

Voltage : Measuring the voltage of vertical parameter. Two horizontal cursors show up.

Time : Measuring the time of horizontal parameter. Two vertical cursors show up.

2)Source(Ch1/Ch2) : Choose the waveform on which to take the cursor measurement.

3)Cursor 1

Displays cursor 1 location.

4)Cursor 2

Displays cursor 2 location.

5)Delta

Display the gap between cursors .Use the function knob to move the cursors. You can move the cursors only while the cursor menu is displayed.

2-2-10 UTILITY

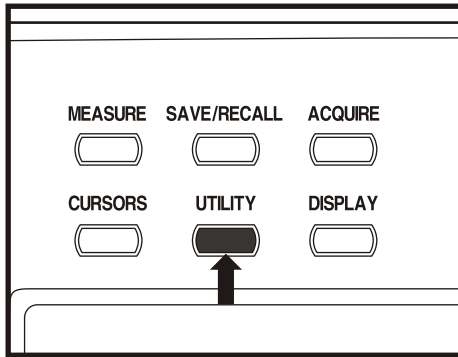

UTILITY

Push the UTILITY button to display the UTILITY menu. The UTILITY menu is changed with the addition of interface modules.

The menu explained here relates to the product without module installed. Refer to the manual supplied with your interface module for items not discussed here.

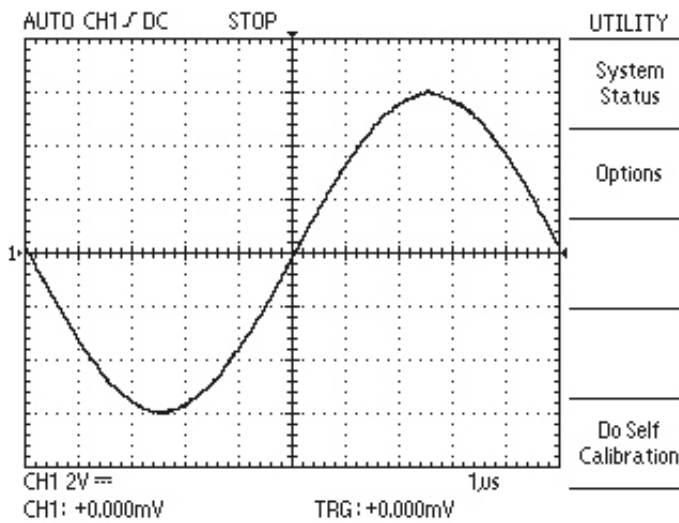

1) System Status

Selecting System Status from the utility menu displays the menus available for obtaining a list of control settings for each group of instrument controls.

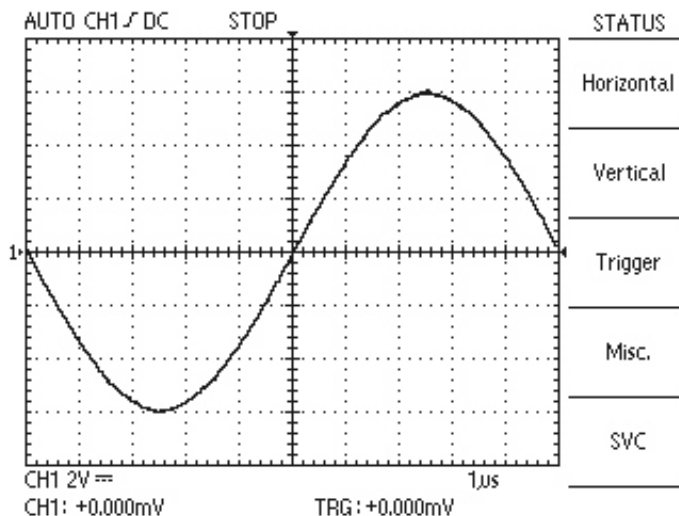

Vertical : Lists vertical parameters of channels.

Horizontal : Lists horizontal parameters of channels.

Trigger : Lists trigger parameters

Misc : Shows the information. That is the software version and processor release level. If the option module is installed, the setting of RS-232C and the setting of hardcopy are add.

SVC : This menu is only used for the service engineer.

2)Options : This menu changes with the addition of option modules. The menus explained here relate to the product with no modules installed. Refer to the manual supplied with your option module for items not discussed here.

3)Do Self Calibration : To operate calibration , " Do Self Calibration" is selected. In order to perform proper correction, be sure to remove all the input signals and probe of input connector before carry out above function.

2-2-11 DISPLAY

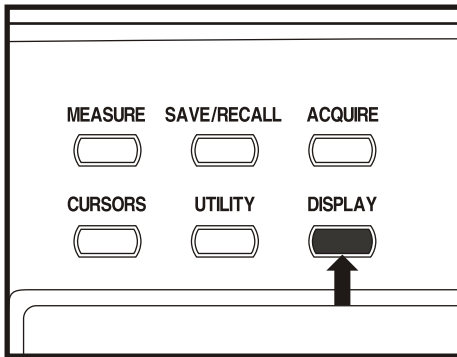

DISPLAY

Push the DISPLAY button to choose how waveforms are presented and to change the appearance of the entire display.

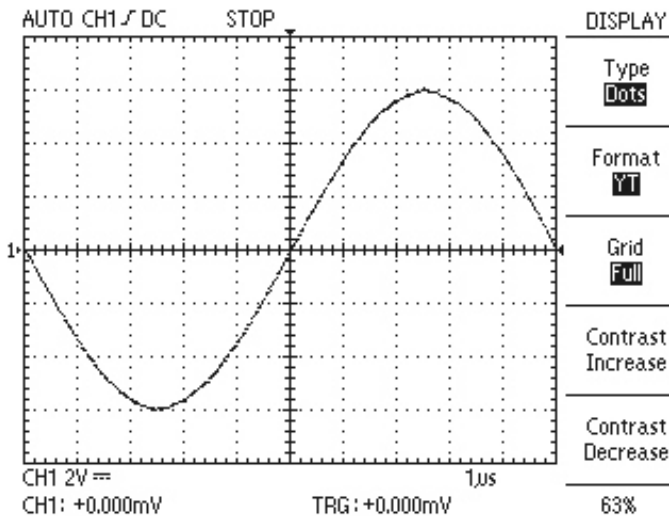

1)Type(Dots/Vectors)

This selects connection mode of acquired waveform data

Dots : Acquired waveform data are displayed on the screen only in the form of dots.

Vectors : Dots of the acquired waveform data form a line and are displayed on the screen. As dots form a line, square waveform signal or rising edge of pulse is able to be easily observed. This is not operated in XY format mode.

2)Format(YT/XY) .

Display mode of waveform is selected by format.

YT : This is a normal type of display and shows a change of signal with the lapse of time.

XY : User compares waveforms of two channels by dots and is able to get phase difference between the signals. Using this menu.

3)Grid(Full/Cross/Board) .

This menu sets the type of measuring grid.

Full : Frame, axis and grid are all displayed. By using this scale, adjust waveform to the scale and then measure the value of the waveform data.

Cross : Frame and axis are displayed. Cross measures a waveform by moving a waveform to the center of the screen.

Board : Only the frame is displayed. When scale is not necessary in measuring the data value of the waveform, or when cursor or field display is not necessary, this mode is selected.

4)Contrast Increase .

Brightness of LCD is brightened by the stage of 5%.

5)Contrast Decrease .

Brightness of LCD is darkened by the stage of 5%.

6)FUNCTION KNOB

Brightness of LCD is changed by the stage of 1%.

2-2-12 HARDCOPY

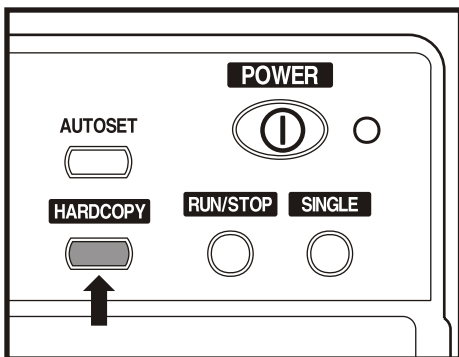

HARDCOPY (Need Interface Card)

Push the HARDCOPY button to print a hard copy of the display. The hardcopy function requires that an interface card with Centronics or RS-232C be installed and connected to a printer.

Refer to the manual supplied with your interface card for instructions on connecting and using the interface card.

To use Hardcopy, the instrument needs to be set appropriately. The setting can be adjusted under "Options" in the "Utility" menu. Detailed information about setting the menu can be referred to "NOTES TO USERS".

Hardcopy supports 3 types: BMP, Centronics, Thermal.

BMP - BMP type is enabled only when used to interface with the PC. To use BMP as a Hardcopy, required are additional programs that enables the PC to receive and save the BMP format. Using EZ Digital's Softview will facilitate saving in the BMP format with ease and convenience. RS232C and USB are both supported, but USB is faster in saving. Softview operates under Windows 98/2000.

Centronics - Centronics type is needed to send the screen data to a printer directly. Centronics type supports HP's PCL level 3 Deskjet and Laserjet printers in general. Even if the brand differs, if the printer has a mode compatible with the PCL level 3 or lower, it's possible to use. Most printers support this format. However, printers that provide the PCL format only through software on PCs and the HP 700 printer series are not supported. Concerning detailed information for PCL format availability, refer to the printer user's manual or visit the printer maker's homepage

Thermal - Thermal type is enabled only by using SANEI's Printy2 thermal printer that supports RS-232C interface.

2-3 USING THE FUNCTIONS EFFECTIVELY

2-3-1 USING THE ZOOM FUNCTION

First of all, set oscilloscope to be in stop status by using RUN/STOP button. When you change time/div rotary switch in stop status, waveform is zoomed in. Following figures show zoom function.

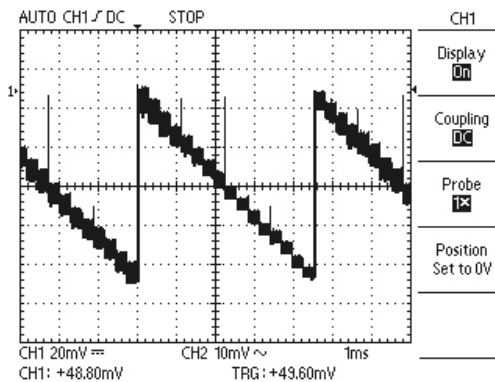

When Oscilloscope is RUN status, Push RUN/STOP button. Oscilloscope will be in STOP status.

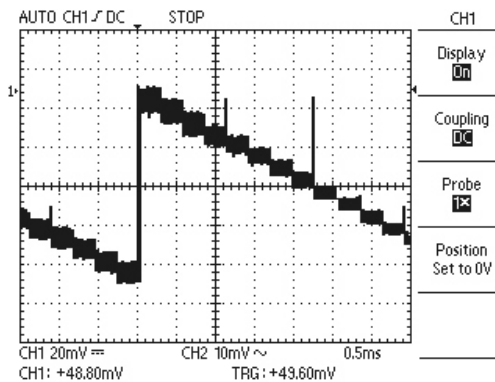

Use TIME/DIV switch to magnify a waveform. Move TIME/DIV switch to lower time division and you will see a magnified waveform.

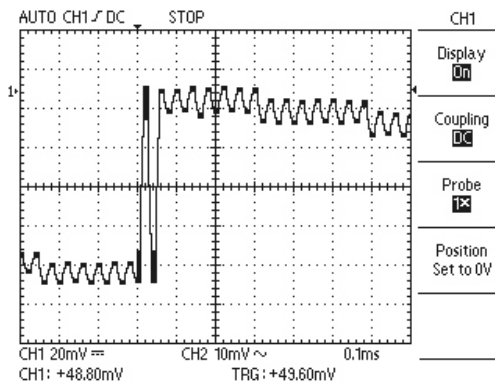

If you want to have more magnified waveform. Move TIME/DIV switch to the next lower time division.

2-3-2 USING THE SINGLE FUNCTION

To capture a single waveform or a noise effectively, do the following steps

1. Adjust the VOLTS/DIV and TIME/DIV to proper ranges.
2. Push the ACQUIRE button and choose Peak Detect On if you want to see the peak value or Peak Detect Off if not.
3. Push the TRIGGER MENU button and select the signal slope.
4. Adjust the trigger level by using the TRIGGER LEVEL knob.
5. Push the SINGLE button on the top of the panel or select single mode in the trigger mode menu. Then, you can see the single ready condition on the top of the screen. "RUN" means ready condition, "STOP" means the end of single capture.

If you want to set single ready condition again, only push the **SINGLE** button or the **RUN/STOP** button.

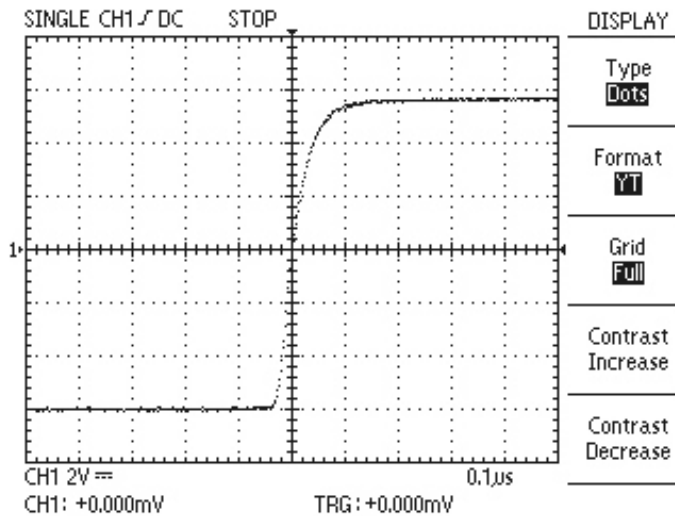

2-3-3 USING FFT(FAST FOURIER TRANSFORMATION)

With Fast Fourier Transform (FFT), you can transform a waveform from a displayed value of its amplitude against time to one that plots the amplitudes of the several discrete frequencies the waveform has. Use FFT in the following applications:

Analyzing impulse response of filters and Amplifier

Analyzing noise in DC power source

Measuring harmonic content and distortion in systems

Analyzing harmonics in 50 and 60 Hz power lines

Analyzing vibration frequency

The FFT computes and displays the frequency content of a waveform you acquire as an FFT math waveform. This frequency domain waveform is based on the following equation:

$$X(k) = \frac{1}{N} \sum_{n=0}^{N-1} x(n)e^{-j2\pi kn/N}$$

Where: $x(n)$ is a point in the time domain record data array

$X(k)$ is a point in the frequency domain record data array

n is the index to the time domain data array

k is the index to the frequency domain data array

N is the FFT length

j is the square root of -1

Procedure of Using FFT

1. Push the math menu button
2. Push the menu button of the advanced function to select FFT.
3. Select FFT source channel
4. Select FFT window (Rectangular, Hamming, Hanning)

Rectangular - Best window for resolving frequencies but worst for accurately measuring the amplitude of those frequencies.

Best window for measuring the frequency spectrum of nonrepetitive signals and measuring frequency components near DC.

Hamming - Very good type for resolving frequencies with somewhat improved amplitude accuracy over the rectangular window.

Hanning - Very good window for measuring amplitude accuracy but degraded for resolving frequencies.

5. Push the menu button of stop

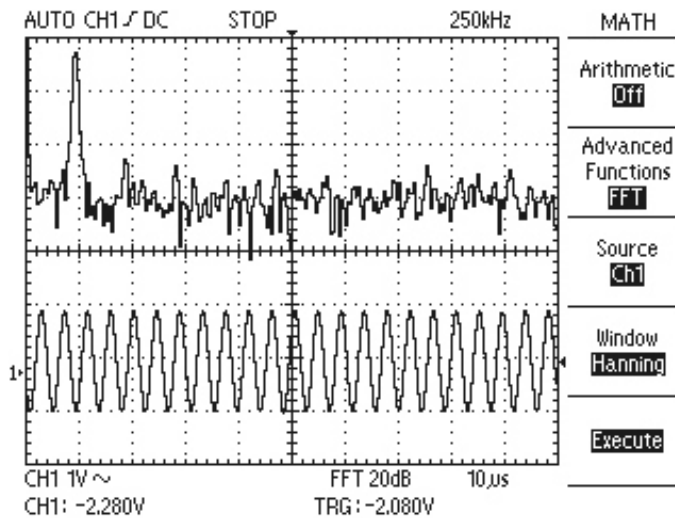

NOTE

The FFT math waveform vertical scale is dB_{RMS} , which is dB relative to 1 V_{RMS} ($0 \text{ dB} = 1 \text{ V}_{\text{RMS}}$).

3. APPENDIX

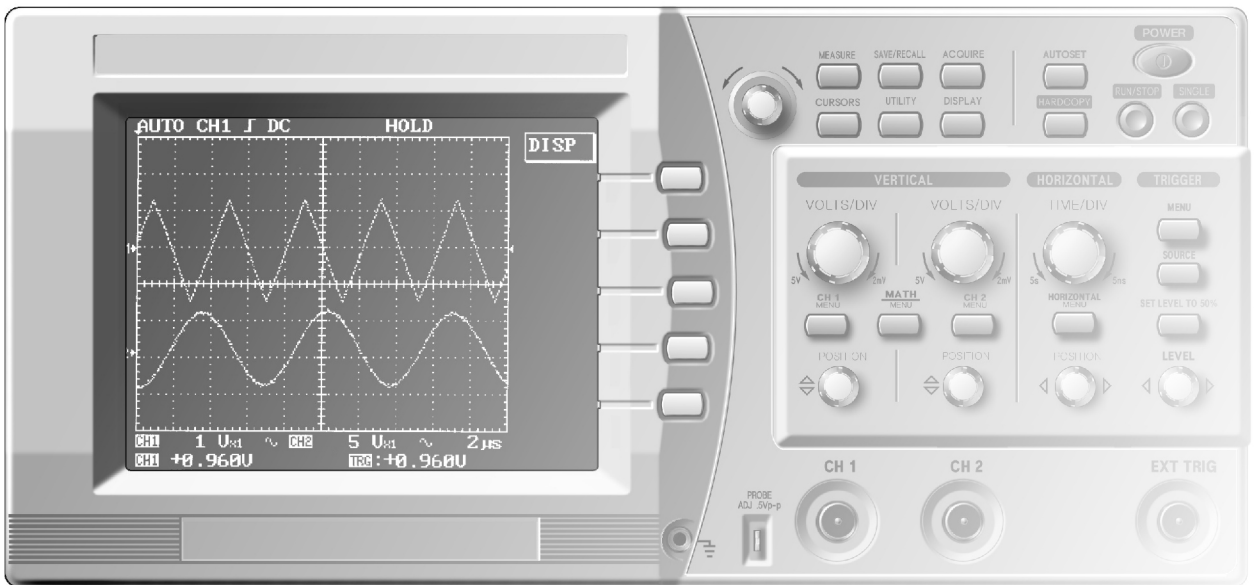

3-1. SPECIFICATIONS

VERTICAL SYSTEM	SPECIFICATION		
	DS-1100	DS-1150	DS-1250
Bandwidth Ch.1 and Ch.2	DC~100MHz (40MHz at 2mV/div)	DC~150MHz (40MHz at 2mV/div)	DC~250MHz (60MHz at 2mV/div)
Input R & C	1M Ω \pm 1.5% , approx. 16 pF		
Dynamic range	More than 8 div at maximum bandwidth		
Sensitivity (per division) Ch.1 and Ch.2	2mV/div ~ 5V/div		
Accuracy	\pm 3%		
Input coupling	AC, DC, GND		
Maximum input	400V (DC + AC PEAK) (AC<1kHz)		
square waveform rising time	Approx. 3.5 ns	Approx. 2.3 ns	Approx. 1.4 ns
Input coupling Offset	\pm 0.2div at 5mV/div~5V/div \pm 0.5 div at 2mV/div		
Cross Talk(Channel Isolation)	Less than 0.3div at 50MHz		
CH1,CH2 Balance(ATT BAL)	\pm 0.2div at 5mV/div~5V/div \pm 0.5 div at 2mV/div		
Drift	\pm 0.3div/h		

HORIZONTAL SYSTEM	SPECIFICATION
Resolution	Approx. 80ps
Time / div	Equivalent: 2ns/div~0.1 μ s/div Real time : 0.25 μ s/div~0.1s/div Roll mode : 0.2s/div~5s/div
Pre trigger	Max 10div
Position movement	10 div
Accuracy	0.01%
Magnification	Zoom In / Out

Acquisition system	SPECIFICATION	
Max Sample rate	200MS/s for one channel 100MS/s per channel 25GS/s per channel in equivalent sampling range	
Sampling resolution	8bit	
Single shot BW	MAX 20MHz	
Peak detect	10ns (5 μ s/div ~ 5s/div)	
Record length	MAX. 10kBytes / ch	MAX. 32kBytes / ch
Average	Number of averages selectable / 2 ~ 128	
Persistence	Real time mode only	

TRIGGER SYSTEM	SPECIFICATION		
Sensitivity Ch.1 and Ch.2	Freq.	5mV~ 5V/div	2mV/div
	DC ~ 10MHz	0.5div	0.5div
	10MHz~ 80MHz	1.5div	1.5div (at 10MHz~60MHz)
	80MHz~MAX. BW	2.0div	
Trigger Type	Edge, TV		
Trigger mode	AUTO, NORM, SINGLE		
Trigger slope	Positive Edge, Negative Edge		
Trigger source	Ch1, CH2, EXT, LINE		
Trigger couple	AC, DC, LF-Reject, HF-Reject		
Trigger sync	Line, Field		
Trigger Level Extent	INT : \pm 3div, EXT : \pm 35% of 4 Vpk		
Set Level to 50%	\pm 0.2div		
External trigger sensitivity	0.2Vpp(DC~150MHz), 0.5V _{p-p} (150MHz~250MHz)		
External Trigger input maximum input	400V(DC+AC PEAK) (AC < 1kHz)		
External trigger input R	About 1M ohm		

DISPLAY SYSTEM	SPECIFICATION
Display	5.7 inch LCD with CCFL Backlight
Resolution	320 X 240 pixels
Controls	Front-panel intensity control

PROBE ADJ	SPECIFICATION
Frequency	1kHz \pm 20%
Voltage	1V \pm 4%

ADVANCED FUNCTIONS	SPECIFICATION
Automatic Measurements	Amplitude (Pk-Pk, RMS, Mean) Frequency, Rise time, Falling time, period Pulse width (positive, negative), Duty ratio
FFT	Rectangular, Hanning, Hamming window
Utility	System condition Self Calibration
Save/Recall	10 waveforms 10 front panel setups
Math (Ch.1 Ch.2)	Addition, subtraction, inversion
Auto Setup	50Hz ~ max. BW at more than 60mVpk, typical
External I/O (option)	RS-232C, SPP ¹ , USB
Hard Copy	Hard copy through the SPP or RS-232C
Supported Printer	Desk Jet™, Laser Jet™ ² with PCL level 3
	Printy 2™ ³ , (RS-232C thermal printer)

1. SPP is standard parallel Port.
2. DeskJet™ and LaserJet™ is registered trademark of HP.
3. Printy2™ is registered trademark of SANEI Electric Inc.

GENERAL	SPECIFICATION
Power Requirement	90VAC ~ 250VAC 48Hz ~ 440Hz
Power Consumption	MAX. 35W
Ambient Temperature Specification guaranteed Operating Storage	10 °C ~ 35 °C (when automatic calibration is performed in the range of 25±5 °C) 0 °C ~ 40 °C -10 °C ~+60 °C
Humidity Operating Storage	45 ~ 80%RH 35 ~ 85%RH
EMC	CE(EN 61326)
Size	370 X 167 X 338 (unit mm)
Weight	5.5kg
Warranty	1 year
Safety	CE(EN 61010-1), C-UL(UL 3111-1/CSA 1010-1) CAT II Pollution degree II

3-2 FACTORY DEFAULTS

ITEM	FACTORY SETTING
CH1 Display	ON
CH1 Input Coupling Mode	DC Coupling
CH1 Volts/div	20mV
CH1 Vertical Position	+ 2 div
CH1 Probe Attenuation Setting	1x
CH2 Display	ON
CH2 Input Coupling Mode	DC Coupling
CH2 Volts/div	20mV
CH2 Vertical Position	- 2 div
CH2 Probe Attenuation Setting	1x
Time Base	0.1ms
Trigger Mode	AUTO
Trigger Source	CH1
Trigger Coupling	DC
Trigger Slope	Rising Slope
Trigger Level	0 div
Run/Stop	RUN
Cursor Mode	OFF
Display Grid	Full
Display Format	YT
Display Type	Vectors
Display Persistence	OFF
Acquire Average	OFF
Acquire Peak Detect	OFF
LCD Contrast	50 %
RS-232C Baud rate	19200
RS-232C Parity	None
RS-232C Data bit	8 bit
Measure	OFF
Math Display	OFF
Recall Display	OFF

SALES: 222-28 Nae-dong, Ojong-gu, Bucheon-si, Gyeonggi-do, 421-160, Korea

Tel : +82-32-681-8380(Rep) Fax: +82-32-681-8404

FACTORY: 5F, Paradise Venture Tower, 708-33 Yeoksam-dong, Gangnam-gu, Seoul, 135-919, Korea

Tel : +82-2-3486-9035(Rep) Fax: +82-2-587-7384

OVERSEAS SUBSIDIARY: Morrow Wave, Inc. 6905 Oslo Circle, Suite J Buena Park, CA 9062, USA.

Tel : 714-739-3800 Fax: 714-739-3805

Home Page: <http://www.ezdt.com>



MMA282-620A

The specifications are subjected to change without notice.