

Altek

Process Calibrator TechChek™ 820



CONTENTS

GENERAL OPERATING INSTRUCTIONS	3
TURN ON	3
CONNECTIONS	3
TILT STAND.....	4
CHANGING BATTERIES.....	4
RESTORING DEFAULT SETTINGS	5
CONFIGURING TEMPERATURE SCALES	5
ENABLING AUTO-OFF	5
SELECTING RANGES	6
SOURCE MODE OPERATING INSTRUCTIONS	7
STORING & RECALLING QUIK-CHEK® OUTPUTS	7
SOURCE MODE CONNECTION INSTRUCTIONS	
CALIBRATE MILLIAMP INPUTS	8
SIMULATE 2-WIRE TRANSMITTERS	9
POWER & MEASURE 2-WIRE TRANSMITTERS	10
CALIBRATE VOLTAGE INPUTS.....	11
CHECK 1-5 VOLT INPUTS WITHOUT	
DISCONNECTING WIRES.....	12
CALIBRATE THERMOCOUPLE INPUTS	13
CALIBRATE RESISTANCE INPUTS	14
CALIBRATE RTD INPUTS	15
CALIBRATE FREQUENCY INPUTS	16
READ MODE OPERATING INSTRUCTIONS	17
MIN/MAX	17
OUT OF RANGE SIGNALS.....	17
READ MODE CONNECTION INSTRUCTIONS	
READ MILLIAMP OUTPUTS.....	18
READ VOLTAGE OUTPUTS	19
MEASURE THERMOCOUPLE SENSORS	20
READ RESISTANCE	21
CHECK CONTINUITY	22
MEASURE RTD SENSORS.....	23
COUNT FREQUENCIES	24
READ AC VOLTAGES	25
SPECIFICATIONS	26
WARRANTY	30

GENERAL INFORMATION

Lighten your load by taking the TechChek to every site. It's like bringing a cartload of test equipment from the shop to the control room or the field. The TechChek 820 sources & reads DC like a milliamp or voltage calibrator, simulates and measures T/Cs & RTDs like a temperature calibrator and generates and counts frequency & Counts-Per-Minute like a frequency calibrator. Your TechChek can also help you trouble shoot like a multimeter! It checks continuity and measures AC line voltage without carrying a separate instrument.

The TechChek 820 is easy to use. Select a function, choose a range, and turn the knob for the precise output you need. Plus, you can store three output values per range for instant recall with the QUIK-CHEK® switch.

MILLIAMP CALIBRATION

Use at every point in your 4 to 20 mA loop. You can Source & Read 0.00 to 24.00 mA, Simulate a Two-Wire Transmitter or the use the TechChek 820 to simultaneously Power & Measure your Two-Wire Transmitters.

VOLTAGE CALIBRATION

Calibrate all your DC millivolt and voltage instrumentation. Source from 0.00 to 110.00 mV and 0.00 to 10.25 V. Read up to 110.00 mV, 11.00 V and 200.0 VDC.

THERMOCOUPLE CALIBRATION

Source and read directly in °C and °F for T/C types J, K, T & E with 1° resolution. Cold junction compensation automatically adjusts for ambient temperature changes.

RTD CALIBRATION

Built-in Platinum 100 Ohm DIN/IEC 751 table displays in °C or °F. No more decade box and hard-to-read tables. Also reads and sources in Ohms.

GENERAL INFORMATION

FREQUENCY CALIBRATION

Generate Zero Crossing square waves from 1 to 1000 Hz, 0.01 to 10.00 kHz and from 1 to 1000 CPM (Counts-Per-Minute). Also measures as a frequency counter.

MEASURE AC VOLTAGE

Check your line voltage or mains from 0.0 to 250.0 volts AC. Great for troubleshooting power problems.

CHECK CONTINUITY

Locate pairs of wire, open connections and shorts with the built-in beeper.

TECHNICIAN'S LEAD KIT

Included with the TechChek 820 is a test lead kit which consists of three safety test leads with alligator clips, test probes and spade lugs.

Rear Label - Condensed Operation Guide

TERMINALS	FUNCTION
①- ②+	SOURCE mA, mV, V, Ω , 2-Wire RTD, Freq
①- ④- ②+	PWR/MEAS mA READ Ω CONTINUITY
④- ③+	SOURCE 3-Wire RTD
④- ⑤+	READ mA, mVDC, Freq & VDC to 10.25V
①+ ②- ③-	SIMULATE 2-Wire Transmitters
④- ⑤+	READ Freq & VAC to 250V, VDC to 200V
①+ ②- ③-	READ 3-Wire RTD
- □ □ +	SOURCE & READ T/C

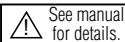

OPERATING INSTRUCTIONS

GENERAL

TURN-ON

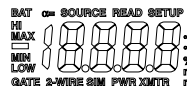

Each time you turn on the TechChek 820 the LCD will display all segments for about 1 second. It then displays the most recently selected Source or Read Setting.

SOURCE - The three QUIK-CHEK outputs will be the same as previously stored. Each time a different function is selected, the three QUIK-CHEK outputs will be recalled.

READ - The 820 is ready to measure the same signal as the last time it was turned on and is automatically updating the MAX & MIN readings for recall at any time.

CONNECTIONS

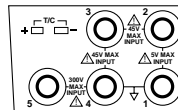

TechChek 820 has protected banana jacks compatible with standard and safety banana plugs. **Included with your TechChek are:** a pair of safety test leads with test probes, safety alligator clips and spade lugs for attachment to a wide variety of instruments. An additional safety test lead and spade lug are also included for 3-Wire RTD connections. Thermocouple connections are made through a miniature thermocouple socket.

Optional KIT-1 includes T/C wires for Type J, T, E & K with miniature T/C plugs (not included).

To prevent accidentally overloading the instrument being tested, it is important to correctly set up the outputs before connecting TechChek 820 to any instruments to be calibrated.

OPERATING INSTRUCTIONS

GENERAL

FIELD & BENCH USE

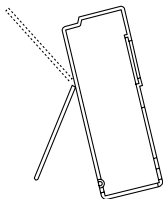

TechChek 820 comes with a carrying case and a built-in tilt stand/hanger. The 820 is held securely in the case by VELCRO® for use with the carrying case open. The carrying case also has a snap-on belt loop which can be looped around a pipe or rail.

The tilt stand is easily raised by pulling the stand until it locks into place. The stand can also be reversed for use as a hanger to suspend the 820.

AUTOCAL

CAL

To maintain accuracy the TechChek periodically recalibrates its measuring circuitry against internal references. While this is occurring the word CAL will appear on the display for less than 2 seconds.

CHANGING BATTERIES

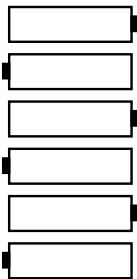

Low battery is indicated by BAT on the display. Approximately four hours of operation remain before the LCD blanks and TechChek 820 shuts itself down. Turn the 820 off, loosen the captive screw securing the battery compartment and lift off the cover from the bottom of the case. The six "AA" batteries are easily removed and replaced (alkaline supplied and recommended). Replace the battery compartment cover by inserting the tabs and tightening the screw.

OPERATING INSTRUCTIONS

GENERAL

CONFIGURING TEMPERATURE SCALES

The thermocouple and RTD ranges may be configured for full time use of °C, full time use of °F or selectable °C and °F operation. This configuration is part of the DEFAULT SETTINGS below.

AUTO-OFF

TechChek 820 can be set up to turn itself off after 30 minutes of inactivity. The internal timer is reset to 30 minutes each time the digital pot is turned or a pushbutton is pressed.

DEFAULT SETTINGS

TechChek 820 may be restored to the factory default setting. This will reset the HI and LO "QUIK-CHEK" memories according to the table below and the SET memory to midrange between HI and LO.

- 1) Press and hold the STORE/RESET push-button while turning the 820 on.
- 2) Keep pressing the push-button until the display flashes (about 5 seconds) then release.
- 3) The °C & °F symbols will flash on the display.
- 4) Press the RANGE/TYPE push-button to make your selection. With °C flashing the unit will only display in °C, With °F flashing the unit will only display in °F and with both flashing you can select °C and °F for each T/C & RTD type. °C/°F is selected if no push-buttons are pressed.
- 5) After five seconds the 820 will automatically store your choice and the words BAT and ON will appear on the display indicating that AUTO-OFF is selected.
- 6) To toggle the AUTO-OFF function on and off press the RANGE/TYPE push-button and the words oN and oFF will display.
- 7) After five seconds the 820 will automatically store your choice.
- 8) All segments on the LCD will remain displayed until the 820 has been reset.

QUIK-CHEK DEFAULTS

RANGE	LO	SET	HI
mA	4.00	12.00	20.00
mV	1.00	5.00	10.00
V	1.00	5.00	10.00
T/C	All points 0°C/32°F		
Ohms	100.0	200.0	400.0
RTD	All points 0°C/32°F		
kHz	1.00	5.00	10.00
Hz	100	500	1000
CPM	100	500	1000

OPERATING INSTRUCTIONS

GENERAL

SELECTING RANGES

RANGE/TYPE

Press the RANGE/TYPE pushbutton to select the desired range and scale.



SOURCE RANGES

Milliamp: mA, %mA, 2-Wire Sim, %2-Wire Sim, Pwr Xmtr, %Pwr Xmtr

VDC: mV, V

T/C: J°F, J°C, T°F, T°C, E°F, E°C, K°F, K°C

Ohms: Ohms

RTD: Pt °F, Pt °C

Frequency: KHz, Hz, CPM

READ RANGES

Milliamp: mA, %mA

VDC: mV, 10V, 200V

T/C: J°F, J°C, T°F, T°C, E°F, E°C, K°F, K°C

Ohms: Ohms, Continuity

RTD: Pt °F, Pt °C

Frequency: KHz, Hz, CPM

VAC: VAC

TURN OFF

POWER

Press the POWER push-button to turn the 820 off. If AUTO-OFF is enabled the 820 will turn itself off after 30 minutes of inactivity.



OPERATING INSTRUCTIONS

SOURCE MODE

Select source by pressing the SOURCE/READ pushbutton until the word SOURCE appears on the LCD display. To change the output value, turn the speed sensitive digital pot. Turning the knob slowly will cause a gradual change in the output. A faster rate of change will occur when the knob is turned faster. This function operates in all three output positions (HI, SET & LO).

STORING QUIK-CHEK OUTPUTS

STORE/RESET



- 1) Switch to HI or LO
- 2) Turn the knob to desired value
- 3) Press the STORE push-button

The LCD will flash once to show that the value was saved

If a value is in the SET position and you want that value stored in HI or LO, press and hold the STORE push-button while moving the switch to HI or LO. The display will flash once to indicate the value has been stored. Then release the STORE push-button.

RECALLING QUIK-CHEK OUTPUTS

SOURCE



When you need a stored value just flip the QUIK-CHEK switch. Any value for the selected range may be stored in HI & LO. The TechChek 820 remembers the HI, LO and SET values for each function with the power on or off. Each time a different function is selected, the last three QUIK-CHEK values for that function will be recalled.

OPERATING INSTRUCTIONS

CALIBRATE MILLIAMP INPUTS

mA, mA % (Percent of 4 to 20 mA)

Choose this function to provide an output from 0.00 to 24.00 milliamps. The compliance voltage is a nominal 25 VDC to provide the driving power to your milliamp receivers.

- 1) Disconnect one or both input wires from the device to be calibrated.
- 2) Connect the red SOURCE lead of the calibrator to the plus (+) input of the device and the black SOURCE lead to the minus (-).
- 3) Repeatedly press the RANGE/TYPE push-button until the word SOURCE and mA or SOURCE and % are displayed.

Output current is continuously adjustable with the "QUIK-CHEK" switch in the SET position. Zero & Span (or any other values) are available by using the LO and HI "QUIK-CHEKS".

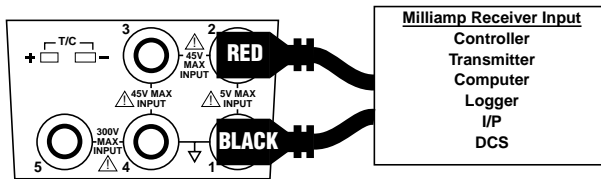

OPERATING INSTRUCTIONS

SIMULATE 2-WIRE TRANSMITTERS

2-WIRE SIM mA, 2-WIRE SIM % (Percent of 4 to 20 mA)

Choose this function to simulate a 2-Wire Transmitter output from 1.00 to 24.00 milliamps. Operates in loops with power supply voltages from 3 to 45 VDC.

- 1) Disconnect existing 2-Wire Transmitter from the loop
- 2) Connect the red SOURCE lead of the calibrator to the plus (+) input of the field connections and the black SOURCE lead to the minus (-)
- 3) Repeatedly press the RANGE/TYPE push-button until the words SOURCE, 2-WIRE SIM and mA or SOURCE, 2-WIRE SIM and % are displayed.

The simulated output of the 2-Wire Transmitter is continuously adjustable from 1.00 to 24.00 mA with the "QUIK-CHEK" switch in the SET position. Zero & Span (or any other values) are available by using the LO and HI "QUIK-CHEKS".

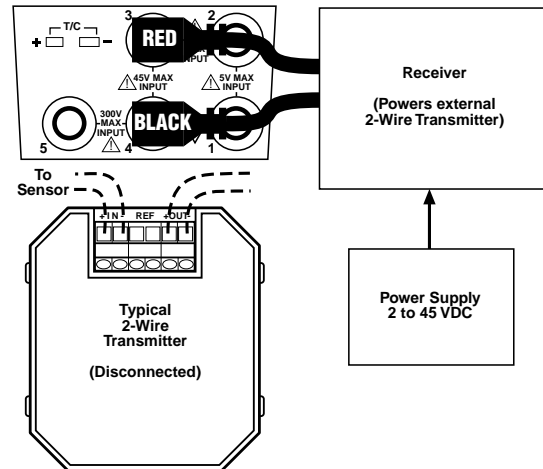

OPERATING INSTRUCTIONS

POWER & MEASURE 2-WIRE TRANSMITTERS

PWR XMTR mA, PWR XMTR %

Choose this function to simultaneously supply power to a 2-Wire transmitter while displaying the 4-20 mA output of the transmitter.

- 1) Disconnect one or both input wires from the 2-Wire Transmitter to be calibrated
- 2) Connect the red SOURCE lead of the calibrator to the plus (+) input of the device and the black SOURCE lead to the minus (-) input of the device
- 3) Connect an appropriate sensor or calibrator to the input of the 2-Wire Transmitter
- 3) Repeatedly press the RANGE/TYPE push-button until the words SOURCE, PWR XMTR and mA or SOURCE, PWR XMTR and % are displayed.

TechChek 820 supplies a nominal 24 Volts DC at 24 mA to the 2-Wire transmitter. The current passed by the transmitter will be accurately displayed by the 820. Calibrate the Transmitter in the usual manner and disconnect the 820.

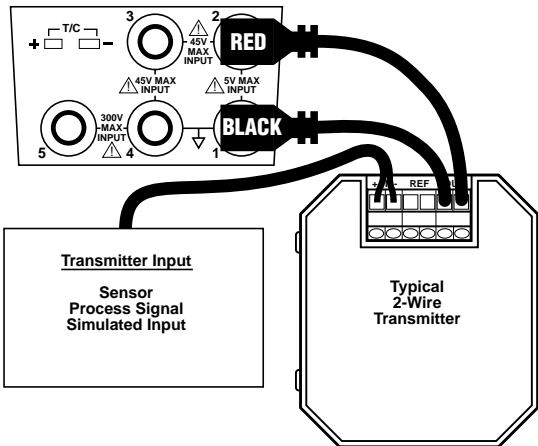

OPERATING INSTRUCTIONS

CALIBRATE VOLTAGE INPUTS

V, mV

Choose this function to provide an output from 0.00 mV to 110.00 mV and from 0.00 to 10.25 VDC. Source current is a nominal 20 mA to provide the driving power to your voltage receivers.

- 1) Disconnect one or both input wires from the device to be calibrated
- 2) Connect the red SOURCE lead of the calibrator to the plus (+) input of the device and the black SOURCE lead to the minus (-) input of the device
- 3) Press the RANGE/TYPE push-button to switch the display between mV and V.

Output voltage is continuously adjustable with the "QUIK-CHEK" switch in the SET position. Zero & Span (or any other values) are available by using the LO and HI "QUIK-CHEKs".

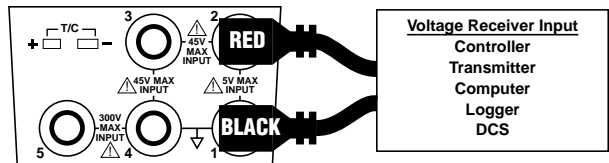

OPERATING INSTRUCTIONS

CHECK 1-5 VOLT INPUTS WITHOUT DISCONNECTING WIRES

Most 1-5 Volt receivers in 4-20mA loops have a 250 Ohm resistor across the input of the receiver. This resistor may be mounted internally or externally. TechChek 820 is connected directly across the input of the 1-5 Volt receiver without disconnecting any field wiring. This saves a great deal of time when a large number of voltage receivers, such as chart recorders or computer systems, require calibration.

Make certain that changing the signal input will not disturb the process or cause unexpected alarms when checking on-line instruments. *It is important to remember the 820 drives only the device to which it is connected.* It has no effect on other devices in the 4 to 20 mA loop. TechChek 820 will clamp the selected value in the mV and V Ranges to the maximum sink current of >16 mA.

- 1) Connect the red SOURCE lead of the calibrator to the plus (+) input of the device and the black SOURCE lead to the minus (-).

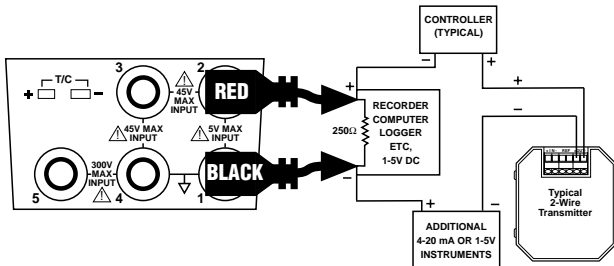

OPERATING INSTRUCTIONS

CALIBRATE THERMOCOUPLE INPUTS

Choose this function to simulate a thermocouple signal into any instrument requiring a thermocouple input. The output of the 820 is automatically cold junction compensated.

- 1) Disconnect the thermocouple from the instrument being calibrated.
- 2) Press the RANGE/TYPE push-button until the desired T/C type and temperature scale appear.
- 3) Use a thermocouple wire and corresponding miniature thermocouple connector to connect the TechChek 820 to the instrument.

Output temperature is continuously adjustable with the "QUIK-CHEK" switch in the SET position. Zero & Span (or any other values) are available by using the LO and HI "QUIK-CHEKS"

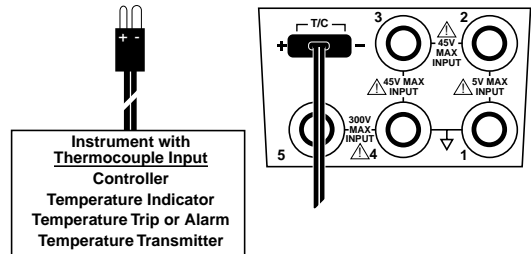

OPERATING INSTRUCTIONS

CALIBRATE RESISTANCE INPUTS

Choose this function to simulate a resistance into a variety of instruments.

- 1) Disconnect one or both input wires from the device to be calibrated.
- 2) Connect the red SOURCE lead of the calibrator to the plus (+) input of the device and the black SOURCE lead to the minus (-) input of the device.

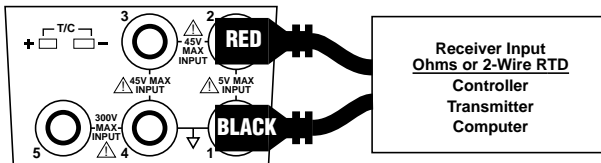

OPERATING INSTRUCTIONS

CALIBRATE RTD INPUTS

Choose this function to simulate a temperature signal into any instrument requiring an RTD input.

- 1) Disconnect the sensing RTD from the instrument being calibrated.
- 2) Press the RANGE/TYPE push-button until the desired RTD type and temperature scale appear.
- 3) Connect using 3 or 2 wires as in the diagrams below. Spade lugs are recommended to minimize any contact resistance.

Output temperature is continuously adjustable with the "QUIK-CHEK" switch in the SET position. Zero & Span (or any other values) are available by using the LO and HI "QUIK-CHEK" positions.

Three Wire RTD Connection

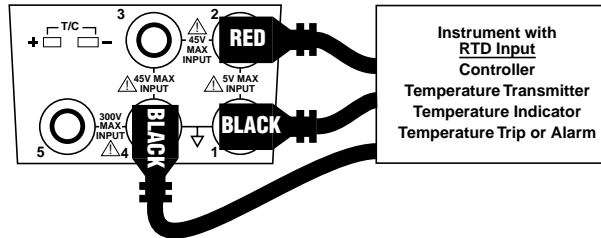

Two Wire RTD Connection

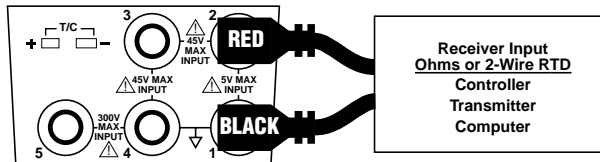

OPERATING INSTRUCTIONS

CALIBRATE FREQUENCY INPUTS

Choose this function to provide pulses into frequency measuring instruments. The 820 output is a zero crossing square wave from -1V to +5V amplitude. Available ranges are from 0.01 to 10.00 kHz, 1 to 1000 Hz and from 1 to 1000 CPM (Counts-Per-Minute). CPM is used to simulate extremely slow frequency signals with greater resolution. For example, 10 Hz is equivalent to 600 CPM. To convert from CPM to Hz Divide by 60. To convert from Hz to CPM multiply by 60.

- 1) Disconnect any input from the instrument being calibrated.
- 2) Press the RANGE/TYPE push-button until the desired frequency range appears.
- 3) Connect the red SOURCE lead of the 820 to the plus (+) input of the device and the black SOURCE lead to the minus (-).

Output frequency is continuously adjustable with the "QUIK-CHEK" switch in the SET position. Zero & Span (or any other values) are available by using the LO and HI "QUIK-CHEKs"

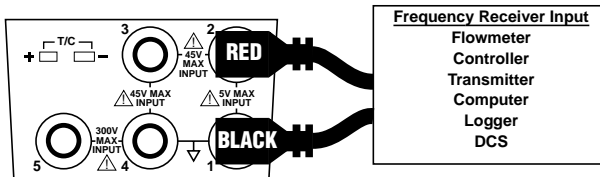

OPERATING INSTRUCTIONS

READ FUNCTIONS

Select read by pressing the SOURCE/READ pushbutton until the word READ appears on the LCD display. The READ functions measure the desired signal. Multiple scales are available for some functions.

MIN/MAX

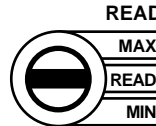

To read the Maximum or Minimum INPUT since READ mode was entered, simply switch to MAX or MIN. The value will appear on the LCD along with the word MAX or MIN. The MAX/MIN values are automatically updated and may be viewed at any time without disturbing the other values.

STORE/RESET



MIN/MAX

Pressing the STORE/RESET push-button will cause the 820 to store the present reading into the MAX and MIN memories. Upon releasing the STORE/RESET push-button the 820 will resume reading the input and update the MAX & MIN values as the measured signal changes.

RESTARTING



SIGNALS

Signals above or below those available for the currently selected range will be indicated by Or and Ur on the display.

OUT OF RANGE

OPERATING INSTRUCTIONS

READ MILLIAMP OUTPUTS

mA, mA % (Percent of 4 to 20 mA)

Choose this function to measure from 0.00 to +24.00 milliamps or -25.0 to 125.0%.

- 1) Open the current loop at any convenient point along the signal path
- 2) Connect the red READ (+) lead of the calibrator to the more positive point of the break and the black READ lead (-) to the more negative

Display the present reading, Maximum or Minimum by moving the toggle switch from READ to MAX or MIN. If TechChek 820 is connected in the wrong polarity, the word POLARITY will appear in the display. Simply reverse the leads for correct indication.

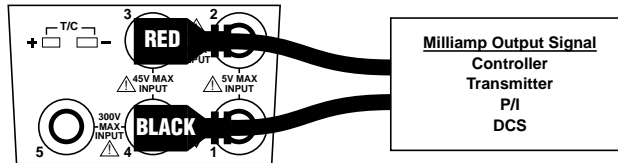

OPERATING INSTRUCTIONS

READ DC VOLTAGE OUTPUTS

V, mV

Choose this function to measure from 0.00 to 10.25 DC Volts. For checking low level sensor outputs and other low levels change the input range to display from 0.00 to 110.00 millivolts. Use the high voltage connection to read from 0.0 to 200.0 VDC

- 1) Connect the red READ (+) lead and the black READ (-) lead of the calibrator across the voltage to be measured.

Signals above or below those available for the currently selected range will be indicated by OVER and UNDER on the display.

Connection for millivolts and Volts below 10.25 VDC

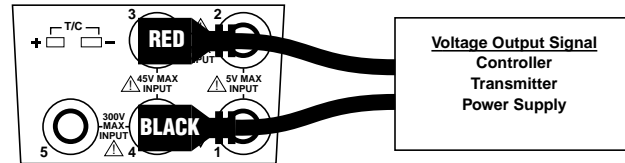

Connection for Volts to 200.0 VDC

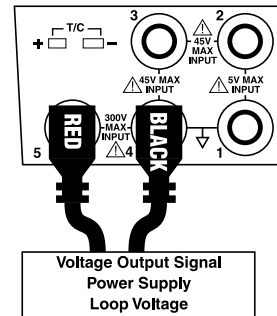

OPERATING INSTRUCTIONS

MEASURE THERMOCOUPLE SENSORS

Choose this function to read a thermocouple. The input of the TechChek 820 is automatically cold junction compensated.

- 1) Disconnect the thermocouple from any instrument.
- 2) Press the RANGE/TYPE push-button until the desired T/C type and temperature scale appear.
- 3) Use the proper thermocouple wire and corresponding miniature thermocouple connector to connect TechChek 820 to the thermocouple.

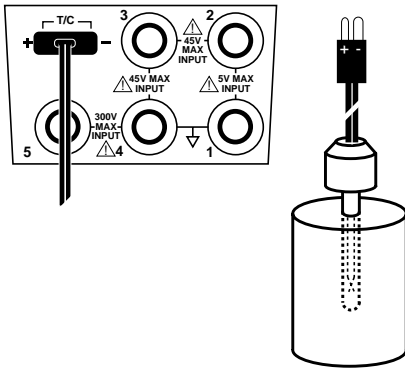

OPERATING INSTRUCTIONS

READ RESISTANCE

Ohms

Choose this function to measure resistance from 0.0 to 1000.0 Ohms.

- 1) Connect the red READ (+) lead and the black READ (-) lead of the calibrator across the resistance to be measured.

Signals above or below those available for the currently selected range will be indicated by OVER and UNDER on the display.

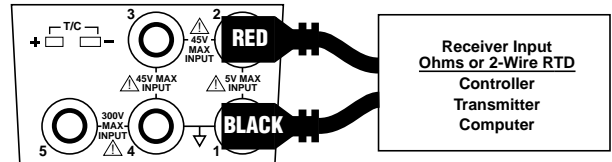

OPERATING INSTRUCTIONS

CHECK CONTINUITY

Choose this function to check continuity. A tone will sound and a sound symbol will appear on the display when the resistance between the leads is less than 100 Ohms.

- 1) Plug the leads into the TechChek 820 as shown below.
- 2) Turn the selector knob to OHMs
- 3) Press the SOURCE/READ pushbutton until the word READ appears on the display.
- 4) Press the RANGE/TYPE pushbutton until the word CONTINUITY appears on the display

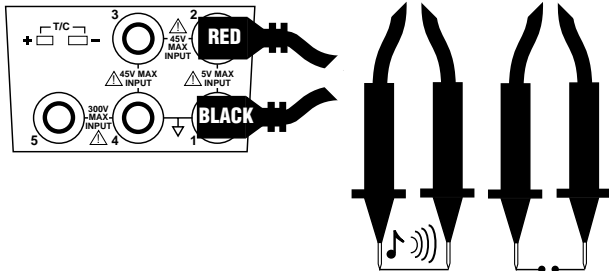

OPERATING INSTRUCTIONS

MEASURE RTD SENSORS

Choose this function to read an RTD. Three wires must be used for both 2 and three wire RTDs.

- 1) Disconnect the RTD from any instrument.
- 2) Press the RANGE/TYPE push-button until the desired RTD type and temperature scale appear.
- 3) Connect using 3 wires as in the diagrams below. Spade lugs are recommended to minimize any contact resistance.

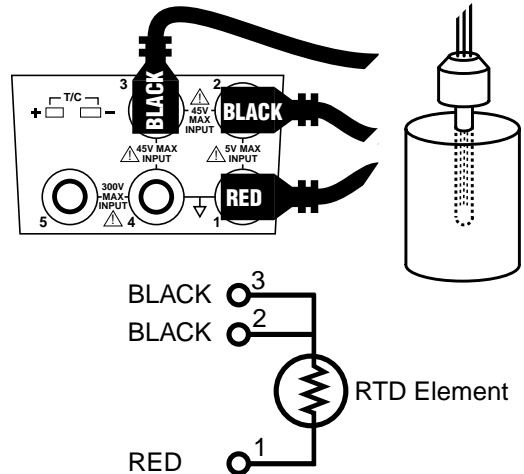

OPERATING INSTRUCTIONS

COUNT FREQUENCIES

Choose this function to use the 820 as a frequency counter. Available ranges are from 0.01 to 10.00 kHz, 1 to 1000 Hz and from 1 to 1000 CPM (Counts-Per-Minute).

To measure waveforms with amplitudes between 1 V and 10.25 V RMS use the low level inputs. Use the high voltage connection to read waveforms with amplitudes from 10.25 to 250.0 V RMS

Connection for signals with amplitudes below 10.25 V RMS

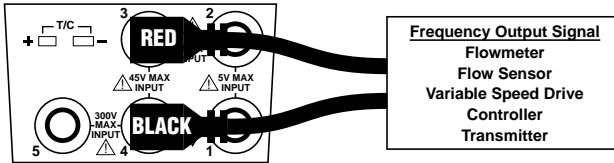

Connection for signals with amplitudes to 250 V RMS

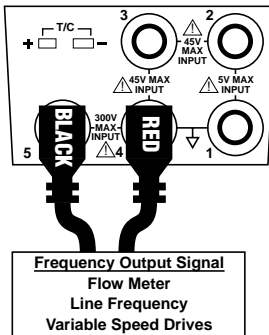

OPERATING INSTRUCTIONS

READ AC VOLTAGES

Choose this function to measure from 0.0 to 250.0 V True RMS.

CAUTION: Care should be used when measuring AC voltage. The included safety test probes or safety alligator clips should be used. Do not exceed voltage limits shown on calibrator.

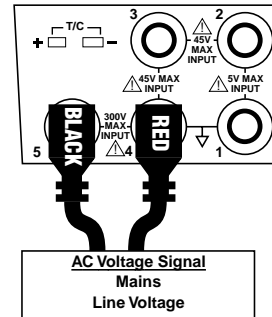

SPECIFICATIONS

GENERAL

TYPICAL 90 DAY ACCURACY: $\pm(0.025\%$ of Full Scale + 1 LSD)¹

1 YEAR ACCURACY: $\pm(0.05\%$ of Full Scale + 1 LSD)

WARM UP TIME: 10 seconds to specified accuracy, 2 minutes to maximum accuracy

TEMPERATURE EFFECT: $\pm 0.01\%/^{\circ}\text{C}$ based on $23^{\circ}\pm 25^{\circ}\text{C}$

BATTERIES: Six "AA", (R6) batteries (Alkaline supplied and recommended)

BATTERY LIFE:

MILLIAMP SOURCE & 2-WIRE MODES: Nominal 50 hours at 12 mA, 20 hours at 20 mA with 250 Ohm load

OTHER FUNCTIONS: Nominal 50 hours

LOW BATTERY INDICATION: "BAT" indication on the display at approximately 4 hours left

OVERLOAD PROTECTION: Three fuses, 250 mA [need rating]

NOISE: ≤ 1 LSD at frequencies less than 10 Hz

NORMAL MODE REJECTION RATIO: 50 dB @ 50/60 Hz

OPERATING TEMPERATURE RANGE: -5 to $+130^{\circ}\text{F}$ (-20 to $+55^{\circ}\text{C}$)

STORAGE TEMPERATURE RANGE: -13 to $+130^{\circ}\text{F}$ (-25 to $+55^{\circ}\text{C}$)

RELATIVE HUMIDITY: 10 to 90%, non-condensing for 24 hours from 0 to 35°C

OVERALL SIZE: 158.1 x 83.1 x 49.3 mm (6.23 x 3.27 x 1.94 inches)

WEIGHT: 0.6 kg (1 lb, 5 oz)

MILLIAMP SOURCE

RANGES:

0.00 to 24.00 mA; -25.0 to 125.0 % of 4 to 20 mA

ACCURACY: $\pm(0.05\%$ of 24 mA Span + 0.01 mA) = 0.02mA

TYPICAL DRIVE CAPABILITY: 1200 Ohms @ 20.00 mA

COMPLIANCE VOLTAGE: nominal 25 V @ 20 mA

¹ Typical 90 day accuracy can be estimated by dividing the 1 year % of full scale accuracy by 2. Additions to the specification, such as + 1 LSD, remain constant.

SPECIFICATIONS

POWER & MEASURE 2-WIRE TRANSMITTERS

RANGES & ACCURACY: Same as for MILLIAMP SOURCE

OUTPUT CURRENT: up to 24.00 mA

TYPICAL DRIVE CAPABILITY: 1200 Ohms @ 20.00 mA

COMPLIANCE VOLTAGE: nominal 25 VDC @ 20 mA

2-WIRE TRANSMITTER SIMULATOR

RANGES:

1.00 to 24.00 mA; -18.8 to 125.0% of 4 to 20 mA

ACCURACY: Same as for MILLIAMP SOURCE

LOOP VOLTAGE LIMITS: Minimum, 3 VDC; Maximum 45 VDC

OVERLOAD PROTECTION: Current limited to 25 mA nominal

MILLIAMP READ

RANGES:

0.00 to 24.00 mA; -25.0 to 125.0 % of 4 to 20 mA

ACCURACY: Same as for MILLIAMP SOURCE

OVERLOAD PROTECTION: Current limited to 25 mA nominal

VOLTAGE BURDEN: 0.9V at 4 mA, 1.2V at 20 mA, 1.9V at 24 mA

DC VOLTAGE SOURCE

RANGES:

0.00 to 110.00 mV; 0.00 to 10.25V

ACCURACY:

$\pm(0.05\%$ of 110 mV + 0.01mV) = ± 0.07 mV

$\pm(0.05\%$ of 10.25 V + 0.01V) = ± 0.02 V

SOURCE CURRENT: >20 mA

SINK CURRENT: >20 mA

OUTPUT IMPEDANCE: <0.3 Ohms

SHORT CIRCUIT DURATION: Infinite

MEASURE AC VOLTS

RANGE: 0.0 to 250.0 V True RMS

ACCURACY: From 10 to 250 VAC $\pm(2\%$ of 250 V + 0.1 VAC) = ± 5.1 VAC

MAXIMUM CREST FACTOR: < 3

FREQUENCY RANGE: 45 to 800 Hz

SPECIFICATIONS

MEASURE DC VOLTS

RANGES:

0.00 to 110.00 mV; 0.00 to 10.25 V; 0.0 to 200.0 V

ACCURACY:

$\pm(0.05\% \text{ of } 110 \text{ mV} + 0.01\text{mV}) = \pm 0.07 \text{ mV}$

$\pm(0.05\% \text{ of } 10.25 \text{ V} + 0.01\text{V}) = \pm 0.02 \text{ V}$

$\pm(2\% \text{ of } 200.0 \text{ V} + 0.1\text{V}) = \pm 4.1 \text{ V}$

INPUT RESISTANCE: >1 Meg Ohm to 10.25V, >5 Meg Ohm to 200V

SOURCE RESISTANCE EFFECT: 0.01% per 100 Ohms

SOURCE THERMOCOUPLES

RANGES:

Type J -100 to 1200°C; -148 to 2192°F

Type K -100 to 1371°C; -148 to 2500°F

Type T -100 to 400°C; -148 to 752°F

Type E -100 to 1000°C; -148 to 1832°F

ACCURACY:

1°C for temperatures above 0°C

2°C for temperatures below 0°C

COLD JUNCTION ACCURACY: $\pm 1^\circ\text{C}$

COLD JUNCTION EFFECT: within 0.05°C per °C change

OVERLOAD PROTECTION: Fused

OUTPUT IMPEDANCE: <0.3 Ohms

SOURCE CURRENT: $\geq 20 \text{ mA}$

READ THERMOCOUPLES

RANGES & ACCURACY: Same as for SOURCE THERMOCOUPLES

INPUT IMPEDANCE: > 1 Meg Ohm

OPEN THERMOCOUPLE DETECTION: 450 millisecond pulse.

Nominal threshold, 10 K Ohms.

SOURCE RTD & OHMS

RANGE OHMS: 0.0 to 400.0 Ohms

ACCURACY: $\pm 0.05\%$ of Full Scale + 0.075 mV/mA Excitation Current

ACCURACY OHMS: $\pm(0.05\% \text{ of } 400.0 \text{ Ohms} + 0.1 \text{ Ohm}) = \pm 0.3 \text{ Ohms}$ (At 1 mA Excitation Current)

SPECIFICATIONS

ACCURACY RTD: $\pm 1^\circ\text{C}$ (At 1 mA Excitation Current)

RTD Type: Pt 100 Ohm DIN/IEC 751, Alpha = 1.3850 (0.00385)

RANGE RTD: -100 to 850°C; -148 to 1562°F

TEMPERATURE EFFECT: $\pm(0.035 \text{ mV}/^\circ\text{C}) \times (1/\text{mA Excitation Current})$

ALLOWABLE EXCITATION CURRENT: 0.125 to 2.0 mA continuous DC

READ RTD & OHMS

RANGE OHMS: 0.0 to 1000.0 Ohms

ACCURACY: $\pm(0.05\% \text{ of } 1000.0 \text{ Ohms} + 0.1 \text{ Ohm}) = \pm 0.6 \text{ Ohms}$

RTD RANGE & ACCURACY: Same as for SOURCE RTDs

EXCITATION CURRENT SUPPLIED: 1 mA, nominal

FREQUENCY SOURCE

RANGES: 1 to 1000 CPM (Count-Per-Minute); 1 to 1000 Hz, 0.01 to 10.00 kHz

ACCURACY:

$\pm(0.05\% \text{ of } 1000 \text{ CPM} + 1 \text{ CPM}) = \pm 2 \text{ CPM}$

$\pm(0.05\% \text{ of } 1000 \text{ Hz} + 1 \text{ Hz}) = \pm 2 \text{ Hz}$

$\pm(0.05\% \text{ of } 10.00 \text{ kHz} + 0.01 \text{ kHz}) = \pm 0.02 \text{ kHz}$

OUTPUT WAVEFORM: Square Wave, Zero Crossing, -1V to +5V $\pm 10\%$

RISETIME: Hz <5 microseconds; CPM <100 microseconds

OUTPUT IMPEDANCE: <100 Ohms

SOURCE CURRENT: >1 mA at 10 kHz

SHORT CIRCUIT DURATION: Infinite

MEASURE FREQUENCY

RANGES & ACCURACY: Same as for FREQUENCY SOURCE

TRIGGER LEVEL: 1 V RMS, DC coupled

INPUT IMPEDANCE: > 1Meg Ohm + 60 pF

CONTINUITY CHECKING

TEST CURRENT: Nominal 1 mA

THRESHOLD: 100 Ohm $\pm 20\%$

INDICATION: Steady tone & Symbol on LCD plus Ohm Reading

WARRANTY

Altek products are warranted to be free from defects in material and workmanship (excluding fuses, batteries and leads) for a period of three years from the date of shipment. Warranty repairs can be obtained by returning the equipment prepaid to our factory. Products will be replaced, repaired, or adjusted at our option. *Altek gives no other warranties, including any implied warranty of fitness for a particular purpose.* Also, Altek shall not be liable for any special, indirect, incidental or consequential damages or losses arising from the sale or use of its products.

NOTES

**MODEL 820 TechChek
PROCESS CALIBRATOR****820**

Included with each Model 820 are:
Carrying Case with belt loop and shoulder strap
Test Lead Kit

Altek Industries, Inc.

PO Box 1106, Everett, WA 98206

1520 75th Street SW, Everett, WA 98203

For more information:

U.S.A. (800) 322-5835

Fax (800) 265-6340

Service fax (425) 446-6331

E-mail: sales@altekcalibrators.com

Web: www.altekcalibrators.com

PN 1839053 Rev A April 2002

©2002 Altek Industries, Inc. Specifications subject to change without notice.

All rights reserved. Printed in U.S.A.